



www.vortice.com



VORT QBK RANGE

COMMERCIAL VENTILATION

NEW

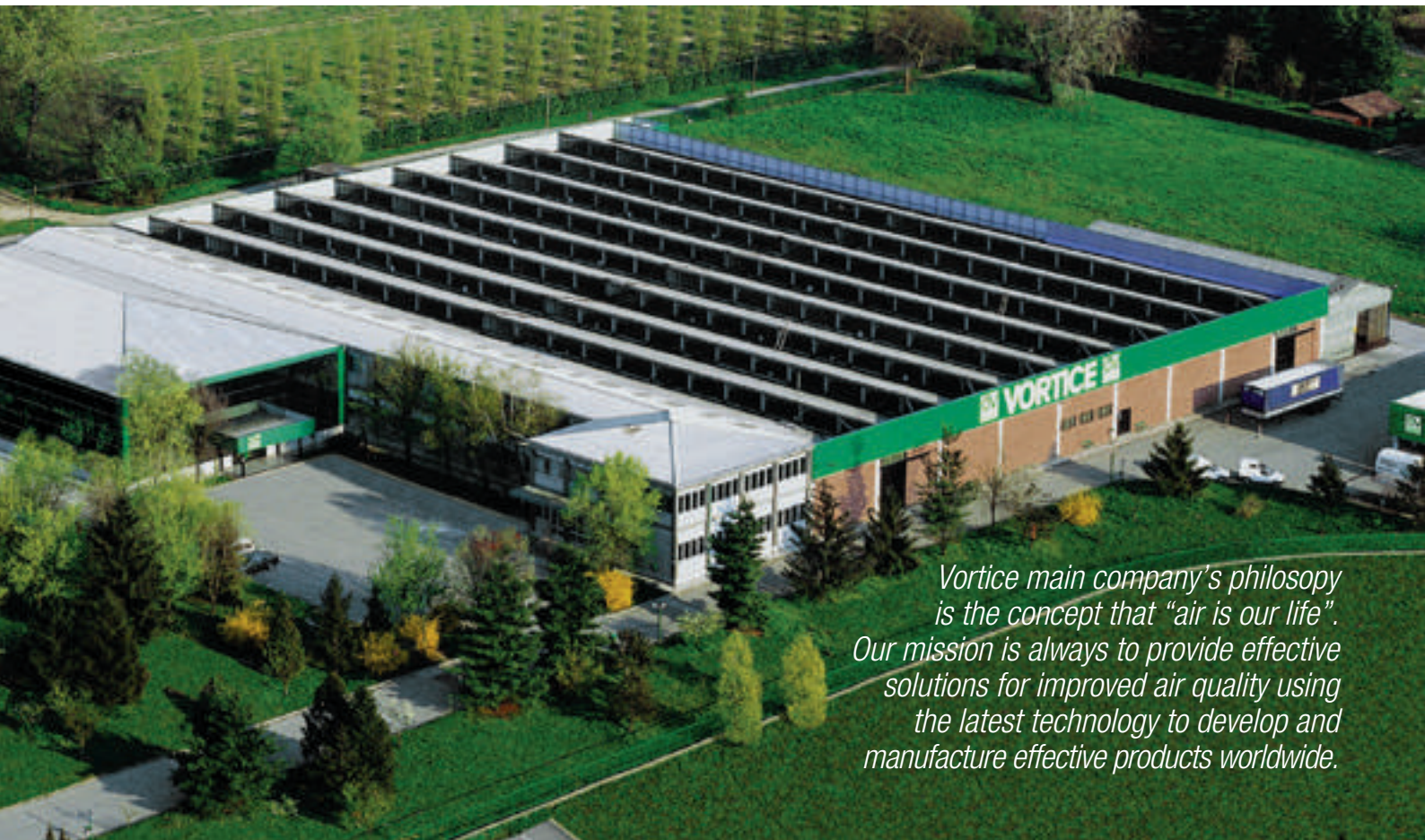

Vortice main company's philosophy is the concept that "air is our life". Our mission is always to provide effective solutions for improved air quality using the latest technology to develop and manufacture effective products worldwide.

Our current Vortice Headquarters have been located in Tribiano (Milan) since 1972.

Vortice has achieved European market leadership by dedicating their efforts to the production of products for ventilation, climate control, heating, extraction, purification and the treatment of air, for domestic, commercial and industrial applications. Since 1954 Vortice has been synonymous with quality and excellence and continues to make significant improvements by investing in continuous research to improve the efficiency and quality of its products.

VORTICE IN THE WORLD

FRANCE



Founded in 1974, Vortice France is located at Créteil about 10 Km from Paris.

ENGLAND



Founded in 1977, Vortice Limited is located at Burton on Trent in the East Midlands.

CHINA



Founded in 2012, Vortice Ventilation System is located about 200 Km from Shanghai.

SOUTH AMERICA



Founded in 2012, Vortice Latam is located in San José, Costa Rica.

INDEX

COMMERCIAL VENTILATION

- 04 **VORT QBK RANGE**
Self-supporting double inlet cabinet fans
- 10 **VORT QBK COMFORT RANGE**
Sound-proof double inlet cabinet fans
- 16 **VORT QBK COMFORT ES RANGE**
Energy saving sound-proof double inlet cabinet fans
- 22 **VORT QBK SAL RANGE**
Double inlet cabinet fans
- 28 **VORT QBK SAL ES RANGE**
Energy saving double inlet cabinet fans
- 34 **VORT QBK - SAL KC RANGE** **NEW AIRSTREAM 120 °C**
Cabinet fans designed to extract hot, humid, dirty air
- 42 **VORT QBK QUIET RANGE**
Sound-proof cabinet fans for residential, commercial and industrial applications
- 48 **VORT TF RANGE**
Twin cabinet fans for commercial and industrial applications
- 52 **VORT QBK POWER RANGE**
Sound-proof double inlet cabinet fans

CE MARKING

The VORT QBK RANGE appliances conform to the following European Directives:

- 2009/125/EC Directive Ecompatible Design (ErP),
- 2006/42/EC Machines Directive (MD),
- 2004/108/EC Electromagnetic Compatibility Directive (EMC),

According to the following state-of-the-art Standards:

Safety:

EN ISO 12100-1; EN ISO 60204-1; EN ISO 13857; EN ISO12499;

Electromagnetic Compatibility:

EN 55014-1; EN 55014-2; EN 61000-3-2; EN 61000-3-3;

The fans built into the VORT QBK Range are conform to the following European Directive N° 327/2011.

LEGEND:

LONG LIFE 30.000 h

The Long Life 30,000 h label certifies that the appliance is guaranteed to operate for 30,000 continuous hours without mechanical failure thanks to its motor, which is equipped with ball bearings. This special configuration allows the appliance to be run continuously, and ensures efficient, silent operation throughout its service life.



The ES label shows that the appliances are fitted with EC Brushless motors and therefore offer guaranteed energy savings, thanks to the wide range of speed regulation options and significantly reduced consumption levels.



The ErP compliant logo indicates that the appliance is eco-compatible and adheres to ErP Directive 2009/125/EC.



VORT QBK RANGE

Self-supporting double inlet cabinet fans

PRODUCT SPECIFICATIONS

LONG LIFE 30.000 h



Designed for ducted ventilation applications: kitchens, bathrooms, offices, laboratories, factories, shops, laundry, restaurants, bars, theatres, ballrooms, etc.

- 8 models, 7 single phase and 1 three phase.
- Flow rates up to 8000 m³/h.
- Zinc-coated self-supporting cabinet (10/10), sound-proof panels, polyethylene padding, with metal and adhesive finishing (10 mm), class I.
- Fan motor units with dynamically balanced twin intake direct feed forward-curved centrifugal blades, made using galvanized steel (ISO standard 1940).
- 1-speed induction motors, all in class F except code 45207 which is in class B, with shafts turning in ball bearings and suitable for control with electronic variable voltage or auto-transformer devices.
- Cable gland for electric cables on front panel.
- Double interchangeable inspection panel with handle and triangular key.
- Operating temperature between -20 and + 70 °C.
- Protection rating: IP20.
- Insulation class: Cl.I Ⓣ .

Fans used in VORT QBK range comply with ErP N° 327/2011/UE.





KEY FEATURES

- Low noise emissions.
- Compact size.
- Designed for application in ventilation duct.
- High performances and reduced maintenance needs.
- Extremely simple, flexible installation.

TECHNICAL DATA

Models	Code	V ~ Hz	W nom/max	A max	Poles	RPM	Max Airflow		Max Pressure		°C Max	IP motor	Kg	
							m³/h	l/s	mmH ₂ O	Pa				
VORT QBK 1000	45260	230~50/60	90 181	0.8	2	1650	547	152	35.7	350	50	54	16	
VORT QBK 7/7 4M 1V	45261	230~50	200 450	2.0	4	1260	1890	525	30.0	295	50	55	18	
VORT QBK 9/9 4M 1V	45263		550 1100	4.7		1290	3420	947	41.9	411	40		32	
VORT QBK 9/9 6M 1V	45262		250 500	2.2	6	800	2900	805	18.5	185	50		29	
VORT QBK 10/10 6M 1V	45264		315 640	2.9	6	600	3700	1028	26.0	255	50		38	
VORT QBK 10/10 4M 1V	45205		600 2200	9.7	4	1400	5148	1426	57.5	564	40		10	33
VORT QBK 12/12 6M 1V	45206		230~50/60	735 1890	8.2	6	735	5600	1551	42.0	411		50	20
VORT QBK 12/12 6T 1V	45207	400~50	1100 2455	4.3	900		8000	2216	33.6	330	55			

VORT QBK RANGE

Self-supporting double inlet cabinet fans

SOUND LEVELS

Models	Code	Speed	125 Hz	250 Hz	500 Hz	1000 Hz	2000 Hz	4000 Hz	8000 Hz	Lw dB (A)	Lp dB (A) 1m*
VORT QBK 1000	45260	1	32.5	38.6	44.0	52.0	49.9	47.2	43.9	55.7	47.6
VORT QBK 7/7 4M 1V	45261		39.7	48.8	52.9	62.6	62.5	60.4	56.8	67.4	59.3
VORT QBK 9/9 6M 1V	45262		43.5	54.3	54.4	62.4	62.7	64.3	54.9	68.6	60.5
VORT QBK 9/9 4M 1V	45263		47.6	61.0	59.7	69.3	70.3	71.0	65.8	75.8	67.8
VORT QBK 10/10 6M 1V	45264		43.9	57.5	55.4	63.1	63.7	63.7	55.5	69.0	61.0
VORT QBK 10/10 4M 1V	45205		50.2	57.2	61.0	66.7	66.7	64.9	59.6	71.8	63.8
VORT QBK 12/12 6M 1V	45206		56.1	59.8	66.2	68.9	69.3	67.5	60.8	74.6	66.6
VORT QBK 12/12 6T 1V	45207		56.0		70.2	71.2	71.4	71.8	65.9	77.6	69.6

*Sound pressure level measured at 1 m in free field conditions with long-cased appliance in delivery mode, in accordance with standard EN ISO 3741

DIMENSIONS

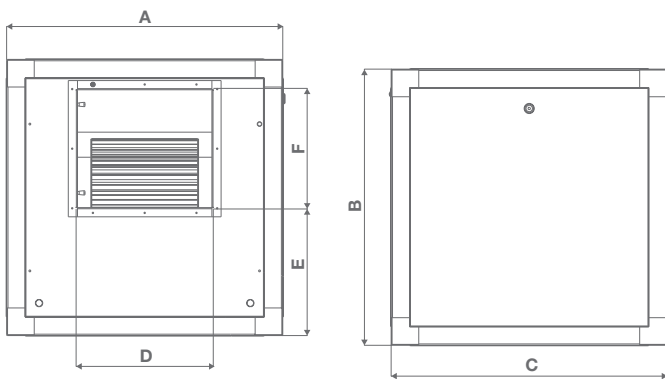

Models	A	B	C	D	E	F
VORT QBK 1000	440	440	440	226	286	92
VORT QBK 7/7 4M 1V				232	172	208
VORT QBK 9/9 6M 1V	480	480	480	298	160	262
VORT QBK 9/9 4M 1V				292	222	256
VORT QBK 10/10 6M 1V	540	540	540	331	192	289
VORT QBK 10/10 4M 1V				331	192	289
VORT QBK 12/12 6M 1V	680	680	680	395	282	341
VORT QBK 12/12 6T 1V				395	282	341

Dimensions (mm)



ACCESSORIES

	Description	Code	Product	
	IREM 3 - Single-phase speed controller	12931	45260 - 45261 - 45264	
	IREM 5 - Single-phase speed controller	12932	45263	
	IREM 9 - Single-phase speed controller	12933	45205 - 45206	
	IRET 6 - Three-phase speed controller	12934	45207	
	QBK ABC - Air cowling	7/7 - 9/9	24200	45260 - 45261 - 45263
		10/10 - 12/12	24202	45264 - 45205 - 45206 - 45207
	QBK RRS - Round nipple joint intake	Ø 250	24205	45260 - 45261
		Ø 315	24206	45263
		Ø 400	24207	45264 - 45205
		Ø 450	24208	45206 - 45207
	QBK RRC - Rain guard	7/7 - 9/9	24209	45260 - 45261 - 45263
		10/10	24210	45264 - 45205
		12/12	24211	45206 - 45207
	QBK F - Feet	24204	for all models	



VORT QBK RANGE

Self-supporting double inlet cabinet fans

PERFORMANCE CURVES

— p= delivery

VORT QBK 1000

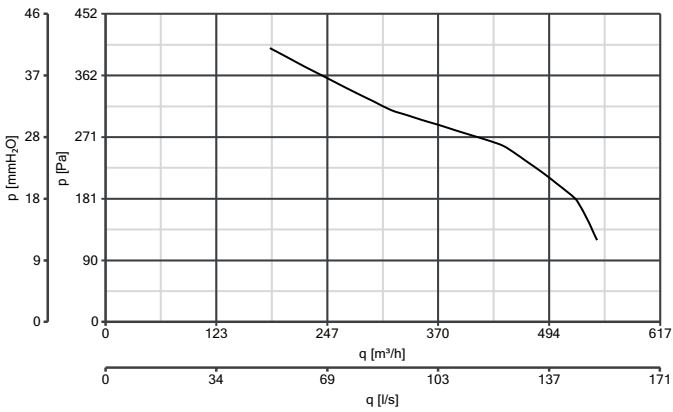

VORT QBK 7/7 4M 1V

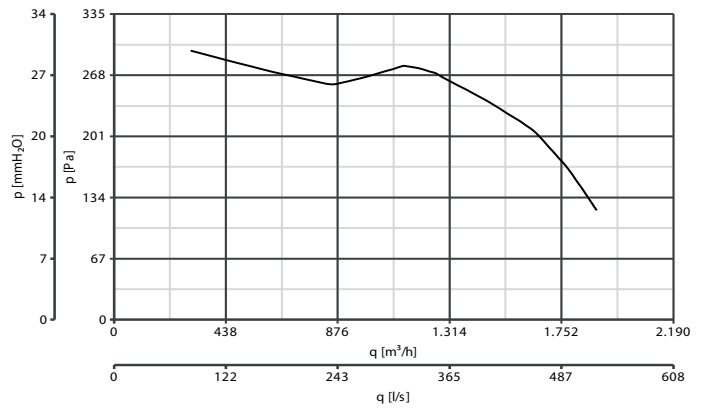

VORT QBK 9/9 6M 1V

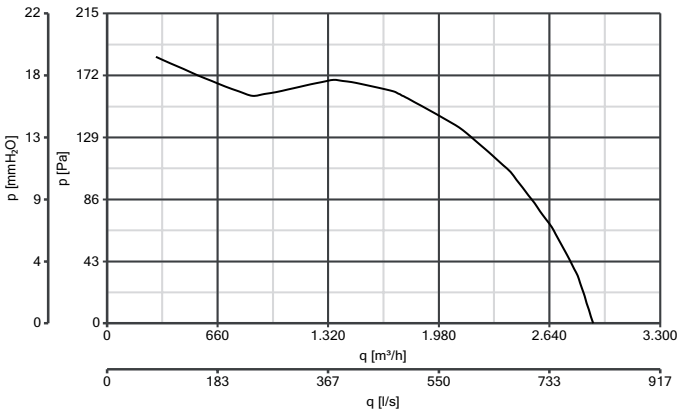

VORT QBK 9/9 4M 1V

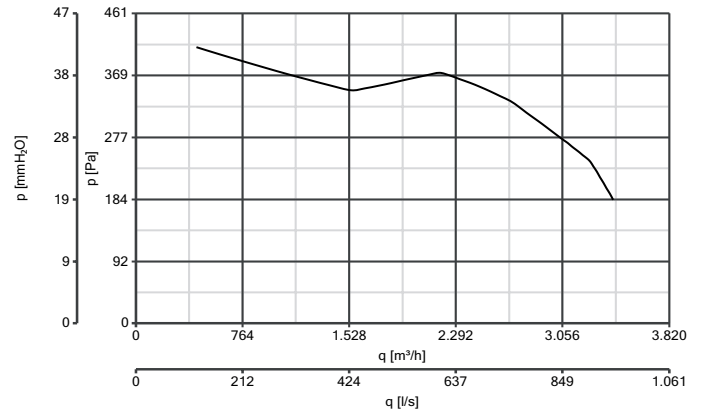

VORT QBK 10/10 6M 1V

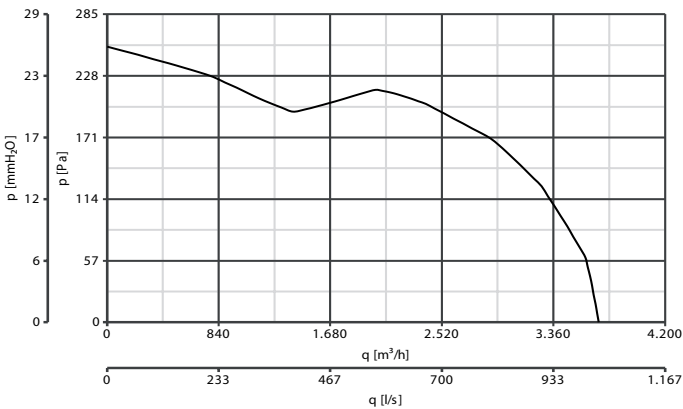

VORT QBK 10/10 4M 1V

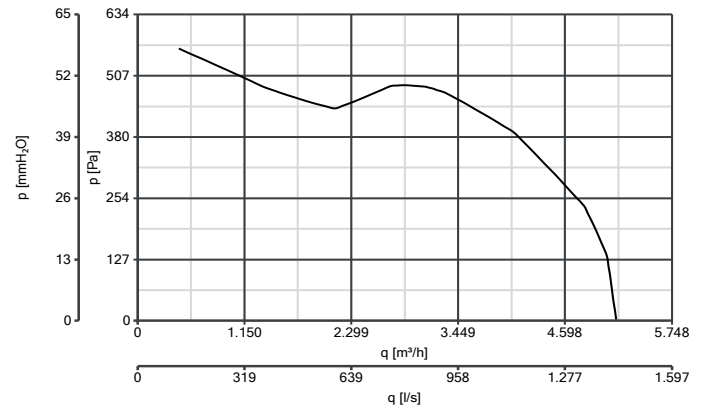

PERFORMANCE CURVES

— p= delivery

VORT QBK 12/12 6M 1V

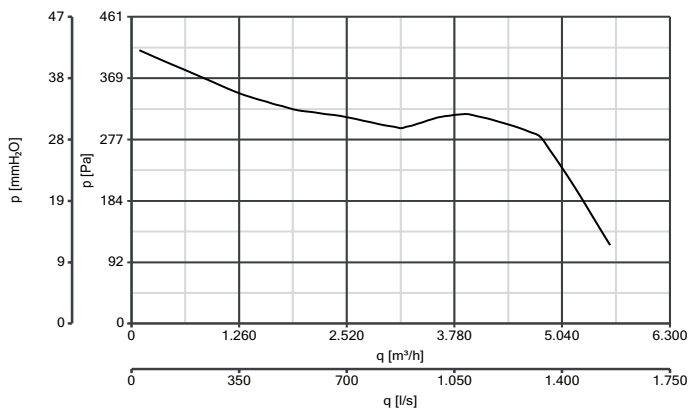

VORT QBK 12/12 6T 1V

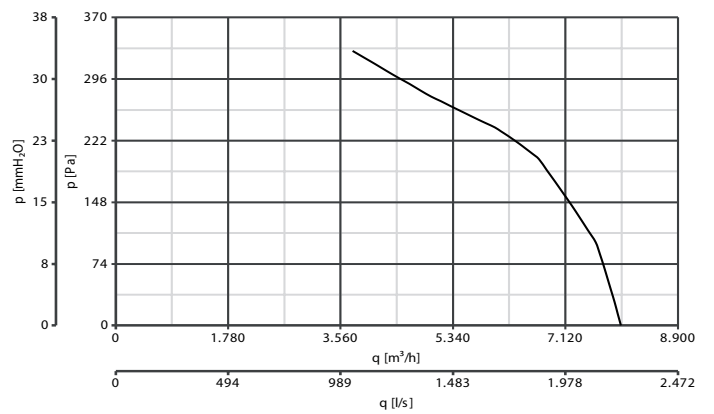

APPLICATIONS



VORT QBK COMFORT RANGE

Sound-proof double inlet cabinet fans

PRODUCT SPECIFICATIONS

Suitable for domestic, commercial and industrial applications: kitchens, bathrooms, offices, laboratories, factories, shops, laundry, restaurants, bars, theatres, ballrooms, etc.

LONG LIFE 30.000 h



- 10 models, 9 single phase e 1 three phase.
- Flow rates up to 8000 m³/h.
- Extruded UNI 9006 aluminium frames assembled with diecast aluminium joints.
- Zinc treated sandwich panels, sound-proof through mineral wool (density 90/100 Kg/m³) covered with 48 mm layer of fibreglass folse.
- Fan motor units with dynamically balanced twin intake direct feed forward-curved centrifugal blades, made using galvanized steel (ISO standard 1940).
- 1-speed induction motors, all in class F except code 45287 which is in class B, with shafts turning in ball bearings and suitable for control with electronic variable voltage or auto-transformer devices.
- 1 inspection panel with locking handle.
- 1 intake panel with smooth round nipple.
- 1 smooth round nipple on inlet vent.
- Operating temperature between -20 and +50°C.
- Protection rating: IP20.
- Insulation class: Cl.I ⊕.

Fans used in VORT QBK COMFORT range comply with ErP N° 327/2011/UE.

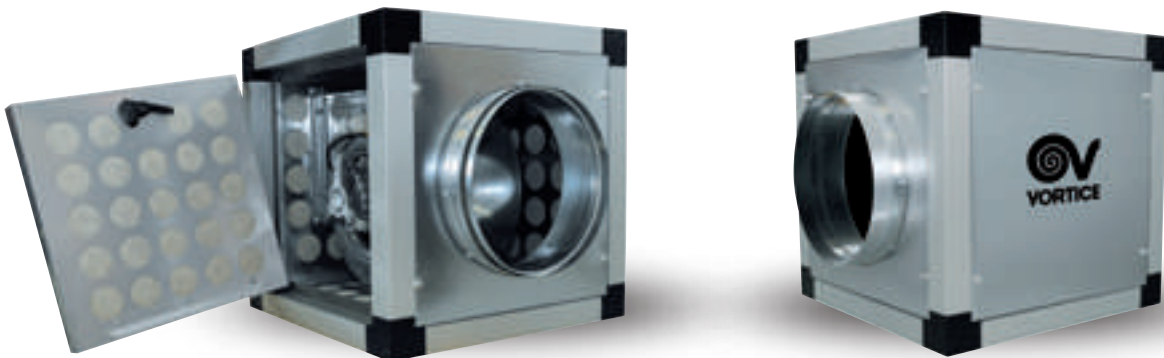



KEY FEATURES

- Low noise emissions.
- Compact size.
- Designed for application in ventilation duct.
- High performances and reduced maintenance needs.
- Flexible installation thanks to being able to adapt the air delivery side to the system requirements by appropriately varying the arrangement of the removable panels of the enclosure depending on the needs of the system.

TECHNICAL DATA

Models	Code	V ~ Hz	W nom/max	A max	Poles	RPM min/max	Max Airflow		Max Pressure		°C Max	IP motor	Kg
							m³/h min/max	l/s min/max	mmH ₂ O min/max	Pa min/max			
VORT QBK COMFORT 500 4V	45288	230~50	nd* 140	0.62	6	1030	610	169	42.3	415	50	20	18
VORT QBK COMFORT 800 MC/H 4V	45250		163 290	1.28		595 1600	315 910	87 253	38.7 51.0	380 500			24.45
VORT QBK COMFORT 1000	45280	230~50/60	90 181	0.80	2	1650	547	152	35.7	350	50	54	32
VORT QBK COMFORT 7/7 4M 1V	45281	230~50	200 450	2.00	4	1260	1890	525	30.0	295			37
VORT QBK COMFORT 9/9 6M 1V	45282		250 500	2.2	6	800	2900	805	18.8	185	40	55	42
VORT QBK COMFORT 9/9 4M 1V	45283		550 1110	4.70	4	1290	3420	947	41.9	411	51		
VORT QBK COMFORT 10/10 6M 1V	45284	230~50/60	315 640	2.90	6	600	3700	1028	26.0	255	50	10	56
VORT QBK COMFORT 10/10 4M 1V	45285	230~50	600 2200	9.70	4	1400	5148	1426	57.5	564			53
VORT QBK COMFORT 12/12 6M 1V	45286		735 1890	8.20	6	735	5600	1551	42.0	411	40	20	73
VORT QBK COMFORT 12/12 6T 1V	45287	400~50	1100 2455	4.30		900	8000	2216	33.6	330	50		



SERIE VORT QBK COMFORT

Sound-proof double inlet cabinet fans

SOUND LEVELS

Models	Code	Speed	125 Hz	250 Hz	500 Hz	1000 Hz	2000 Hz	4000 Hz	8000 Hz	Lw dB (A)	Lp dB (A) 1m*
VORT QBK COMFORT 500 4V	45288	4 - max	29.2	32.2	38.0	39.5	33.0	12.6	<10	43.0	35.0
		3	21.3	24.7	30.8	29.8	24.6	34.6		26.6	
		2	15.1	19.4	26.3	24.0	17.6	29.3		21.3	
		1 - min	10.8	14.4	19.7	16.1	10.1	22.7		14.7	
VORT QBK COMFORT 800 MC/H 4V	45250	4 - max	46.3	52.3	54.6	51.2	47.1	29.1	20.4	58.5	50.4
		3	44.1	45.9	48.8	46.4	41.5	23.1	13.9	53.0	45.0
		2	38.3	39.3	42.1	40.3	34.1	14.8	<10	46.5	38.5
		1 - min	28.4	30.3	35.0	31.8	25.3	<10		38.3	30.3
VORT QBK COMFORT 1000	45280	1	26.3	32.2	39.3	42.7	38.9	17.7	7.2	45.7	37.7
VORT QBK COMFORT 7/7 4M 1V	45281		33.5	42.4	48.2	53.3	51.5	30.9	20.1	56.5	48.4
VORT QBK COMFORT 9/9 6M 1V	45282		37.3	47.9	49.7	53.1	51.7	34.8	18.2	57.1	49.1
VORT QBK COMFORT 9/9 4M 1V	45283		41.4	54.6	55.0	60.0	59.3	41.5	29.1	64.0	55.9
VORT QBK COMFORT 10/10 6M 1V	45284		37.78	51.1	50.7	53.8	52.7	34.2	18.8	58.3	50.3
VORT QBK COMFORT 10/10 4M 1V	45285		44.0	50.8	53.3	57.4	55.7	35.4	22.9	64.0	56.7
VORT QBK COMFORT 12/12 6M 1V	45286		49.0	53.4	61.5	59.6	58.3	38.0	24.1	68.2	60.2
VORT QBK COMFORT 12/12 6T 1V	45287		49.8		65.5	61.9	60.4	42.3	29.2	71.2	63.1

*Sound pressure level measured at 1 m in free field conditions with long-cased appliance in delivery mode, in accordance with standard EN ISO 3741.

DIMENSIONS

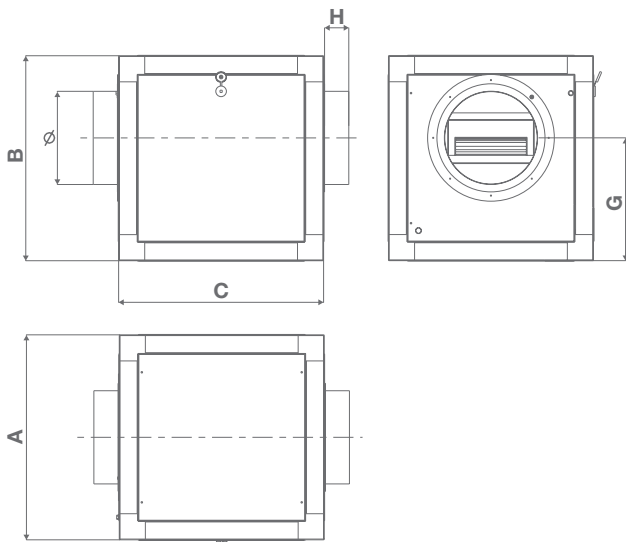

Models	A	B	C	G	H	Ø
VORT QBK COMFORT 500 4V	400	230	230	45	200	200
VORT QBK COMFORT 800 MC/H 4V						
VORT QBK COMFORT 1000	550	330	330	65	250	250
VORT QBK COMFORT 7/7 4M 1V						
VORT QBK COMFORT 9/9 6M 1V						
VORT QBK COMFORT 9/9 4M 1V	650	417.5	417.5	60	315	250
VORT QBK COMFORT 10/10 6M 1V						
VORT QBK COMFORT 10/10 4M 1V						
VORT QBK COMFORT 12/12 6M 1V	750	450	450	90	400	400
VORT QBK COMFORT 12/12 6T 1V						

Dimensions (mm)



ACCESSORIES

	Description	Code	Product	
	IREM 3 - Single-phase speed controller	12931	45280 - 45281 - 45284	
	IREM 5 - Single-phase speed controller	12932	45283	
	IREM 9 - Single-phase speed controller	12933	45285 - 45286	
	IRET 6 - Three-phase speed controller	12934	45287	
	C4VM16 - Three-phase speed controller	14021	45288 - 45250	
	QBK RRC COMFORT - Rain guard	7/7 - 9/9	24212	45280 - 45281
		10/10	24213	45283 - 45284 - 45285
		12/12	24214	45286 - 45287
	QBK F - Feet	24247	for all models	

APPLICATIONS





VORT QBK COMFORT RANGE

Sound-proof double inlet cabinet fans

PERFORMANCE CURVES

— Max — Min

VORT QBK COMFORT 500 4V

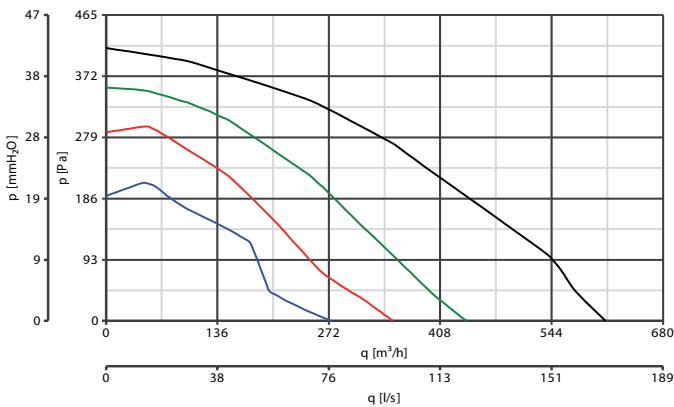

VORT QBK COMFORT 800 MC/HV 4V

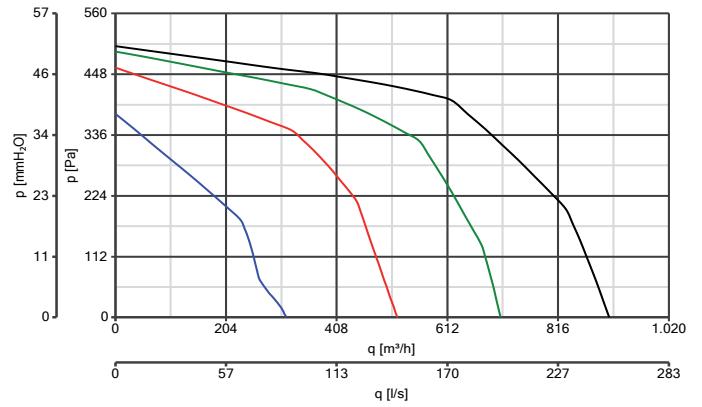

— p= delivery

VORT QBK COMFORT 1000

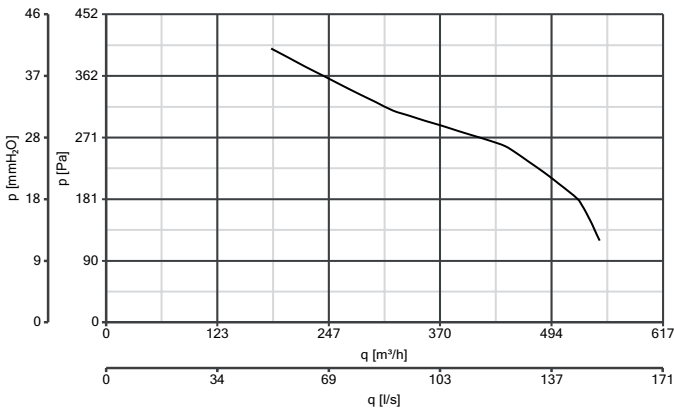

VORT QBK COMFORT 7/7 4M 1V

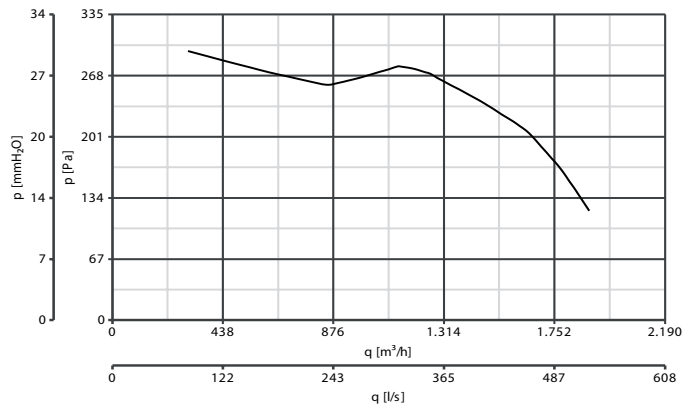

VORT QBK COMFORT 9/9 4M 1V

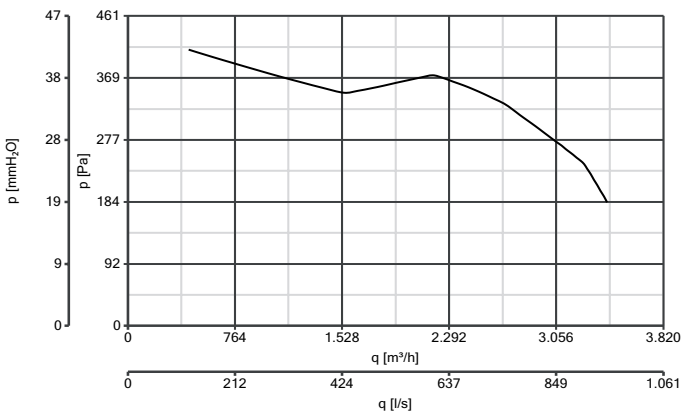

VORT QBK COMFORT 9/9 6M 1V

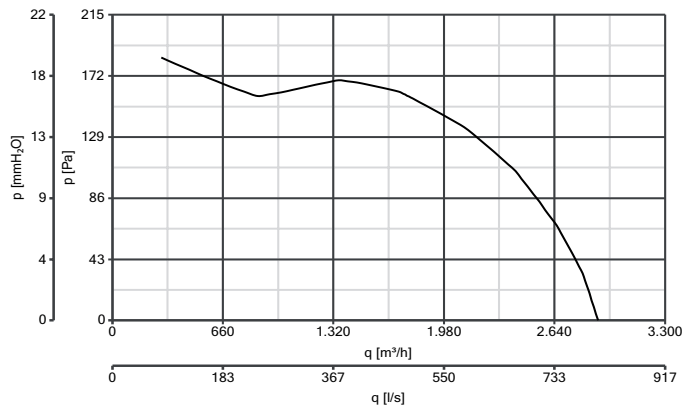



PERFORMANCE CURVES

— p= delivery

VORT QBK COMFORT 10/10 6M 1V

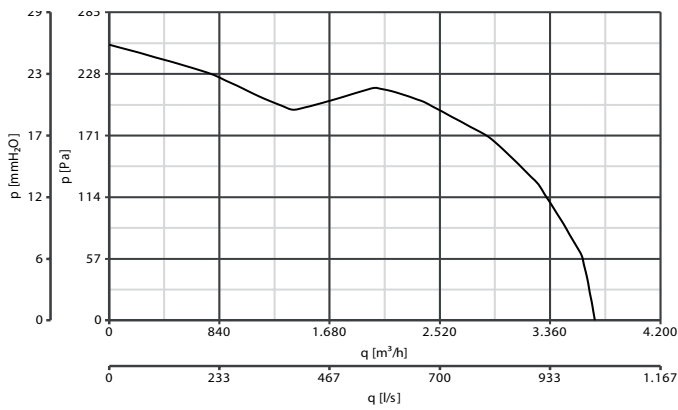

VORT QBK COMFORT 10/10 4M 1V

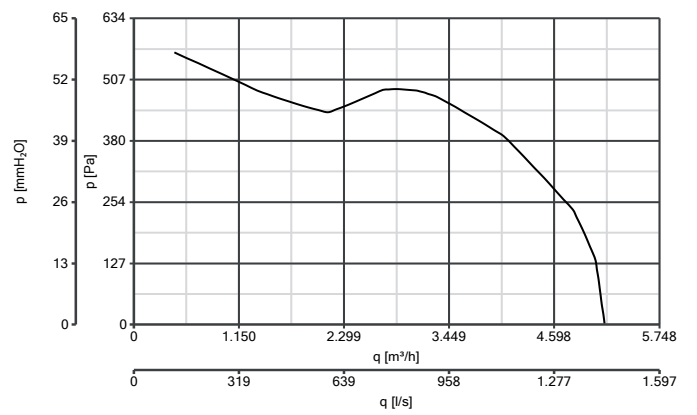

VORT QBK COMFORT 12/12 6M 1V

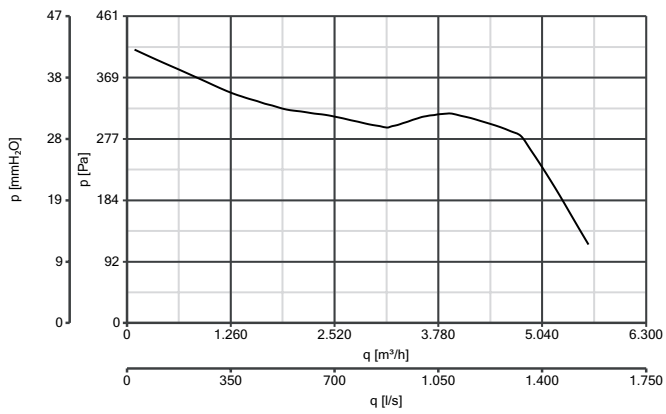

VORT QBK COMFORT 12/12 6T 1V

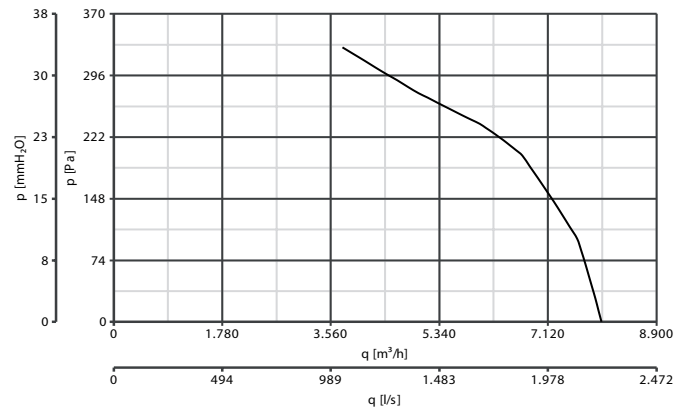



VORT QBK COMFORT ES RANGE

Energy saving sound-proof double inlet cabinet fans

PRODUCT SPECIFICATIONS

Ideal for residential, commercial and industrial ventilation: kitchens, bathrooms, offices, laboratories, factories, shops, laundry, restaurants, bars, theatres, ballrooms, etc.

LONG LIFE 30.000 h



- 5 models single phase.
- Flow rates up to 5500 m³/h.
- Extruded UNI 9006 aluminium frames assembled with diecast aluminium joints.
- Zinc treated sandwich panels, sound-proof through mineral wool (density 90/100 Kg/m³) covered with 48 mm layer of fibreglass.
- Fan motor units with dynamically balanced twin intake direct feed forward-curved centrifugal blades, made using galvanized steel (ISO standard 1940).
- Brushless motors, all in class F, with shafts turning in ball bearings and suitable for control with external potentiometer (signal 0-10 V), supplied as standard.
- 1 inspection panel with locking handle.
- 1 intake panel with smooth round nipple.
- 1 smooth round nipple on inlet vent.
- Operating temperature between -20 and +40°C.
- Protection rating: IP20.
- Insulation class: Cl.I ⊕.

Fans used in VORT QBK COMFORT ES range comply with ErP N° 327/2011/UE.





KEY FEATURES

- Low power consumption coupled with high performance thanks to brushless EC motors.
- Low noise emissions.
- Wide range of speed adjustment by means of an external potentiometer (signal 0-10 V).
- High dependability and reduced maintenance requirement.
- Designed for application in ventilation duct.
- Flexible installation thanks to being able to adapt the air delivery side to the system requirements by appropriately varying the arrangement of the removable panels of the enclosure depending on the needs of the system.
- The speeds of the fan units are adjustable with an external potentiometer included (0-5V or 0-10V DC signal).

TECHNICAL DATA

Models	Code	V ~ 50/60 Hz	W max	A max	RPM*	Max Airflow		Max Pressure		°C Max	IP motor	Kg
						m ³ /h	l/s	mmH ₂ O	Pa			
VORT QBK COMFORT ES 1000	45170	230	260	1.8	2100	1070	297	80	785	40	20	35
VORT QBK COMFORT ES 7/7 M	45171				2000	2850	792	60	588			
VORT QBK COMFORT ES 9/9 M	45172		1100	4.6	1450	3240	900	88	863		44	38
VORT QBK COMFORT ES 10/10 M	45173				1100	4250	1181	116	1138			
VORT QBK COMFORT ES 12/12 M	45175		1700	7.0	950	5500	1528	118	1157		54	79

* RPM measured at the point of maximum air flow.

The performance data are relative to the F.M.W.L. (Fan Max Working Limit) maximum use curve obtained with the highest DC motor setting.

VORT QBK COMFORT ES RANGE

Energy saving sound-proof double inlet cabinet fans

SOUND LEVELS

Models	Code	Speed	125 Hz	250 Hz	500 Hz	1000 Hz	2000 Hz	4000 Hz	8000 Hz	Lw dB (A)	Lp dB (A) 3m*
VORT QBK COMFORT ES 1000	45170	Max	19.6	41.6	38.6	38.7	40.1	41.3	36.2	52.6	32.1
VORT QBK COMFORT ES 7/7 M	45171		40.9	53.8	48.5	41.1	47.7	50.9	46.1	61.7	41.2
VORT QBK COMFORT ES 9/9 M	45172		48.6		48.4	48.1	46.2	47.2	39.3	61.6	41.1
VORT QBK COMFORT ES 10/10 M	45173		44.4	53.2	50.9	51.6	47.7	48.5	31.9	62.5	42.0
VORT QBK COMFORT ES 12/12 M	45175		49.6	56.0	53.6	53.3	46.8	46.5	30.8	64.5	44.0

*Sound pressure level measured at 3 m in free field conditions with long-cased appliance in delivery mode, in accordance with standard EN ISO 3741.

DIMENSIONS

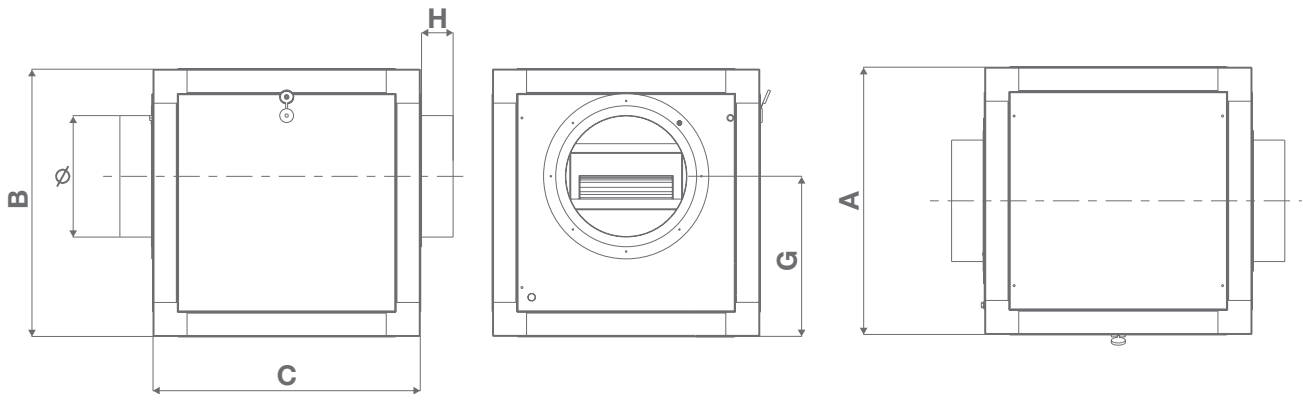

Models	A	B	C	G	H	Ø
VORT QBK COMFORT ES 1000	550	650	750	330	60	250
VORT QBK COMFORT ES 7/7 M				317.5		
VORT QBK COMFORT ES 9/9 M	450	750	750	375	90	400
VORT QBK COMFORT ES 10/10 M				450		450



Dimensions (mm)



VORT QBK
COMFORT ES
RANGE

CABINET FANS
ENERGY SAVING
SOUND-PROOF

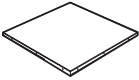
ACCESSORIES

	Description	Code	Product	
	QBK RRC COMFORT - Rain cover	7/7 - 9/9	24212	45170 - 45171
		10/10	24213	45172 - 45173
		12/12	24214	45175
	QBK F - Feet	24247	all models	

APPLICATIONS





VORT QBK COMFORT ES RANGE

Energy saving sound-proof double inlet cabinet fans

PERFORMANCE CURVES

— Delivery — Power consumption

VORT QBK COMFORT ES 1000

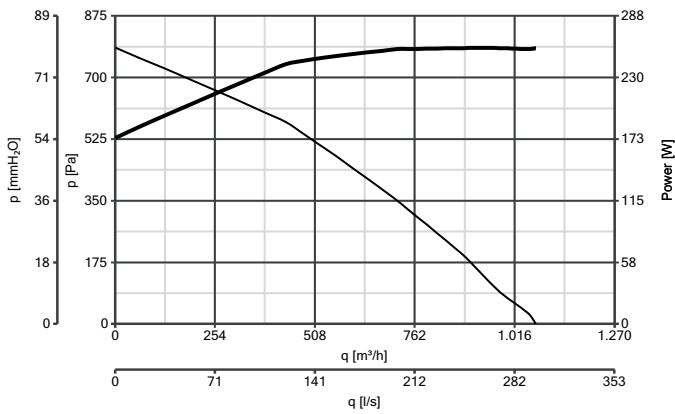

VORT QBK COMFORT ES 7/7 M

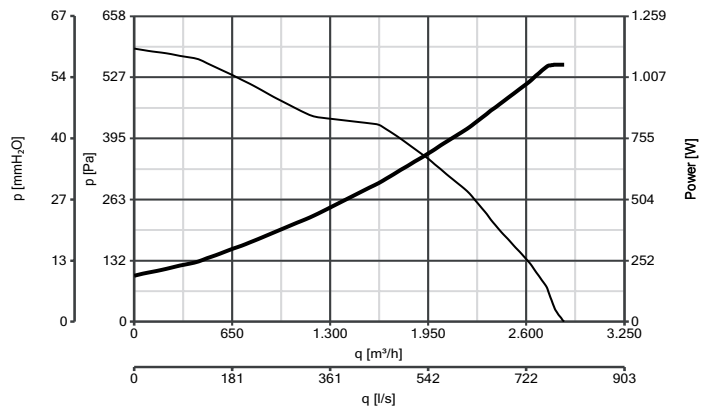

VORT QBK COMFORT ES 9/9 M

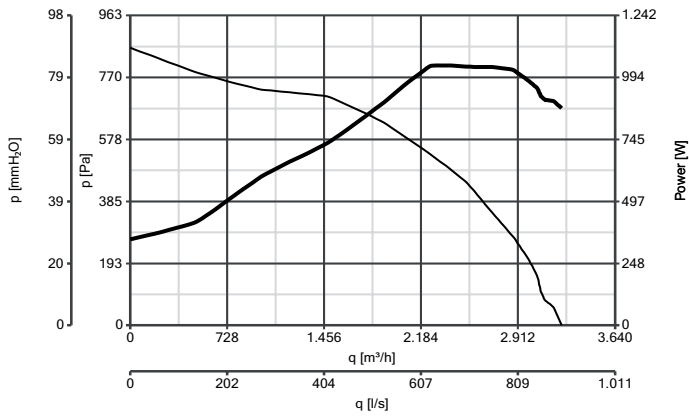

VORT QBK COMFORT ES 10/10 M

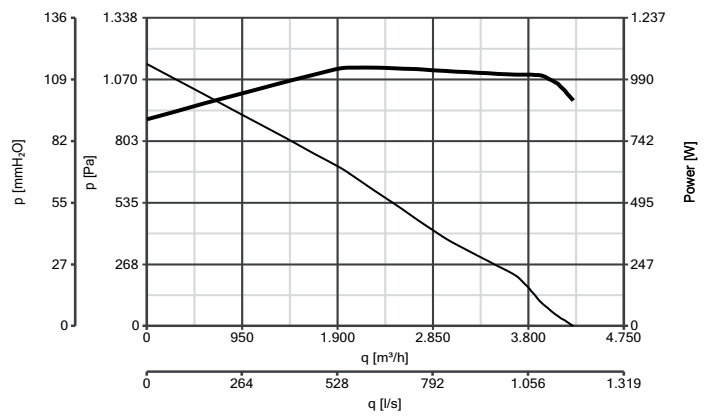

VORT QBK COMFORT ES 12/12 M

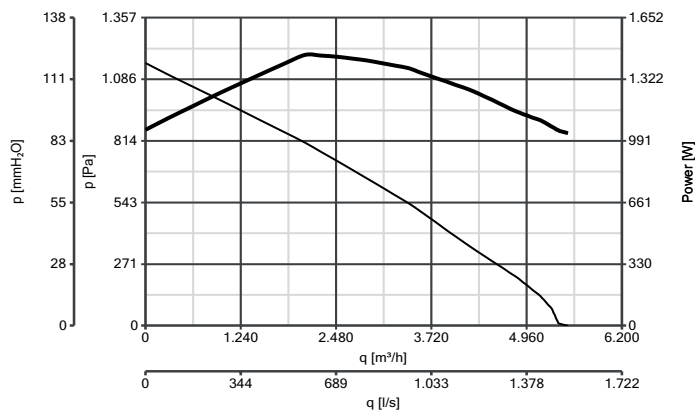

VORT QBK SAL RANGE

Double inlet cabinet fans

PRODUCT SPECIFICATIONS

Designed for ducted ventilation applications: kitchens, bathrooms, offices, laboratories, factories, shops, laundry, restaurants, bars, theatres, ballrooms, etc.

LONG LIFE 30.000 h



- 8 models, 7 single phase and 1 three phase.
- Flow rates up to 8000 m³/h.
- Extruded UNI 9006 aluminium frames assembled with diecast aluminium joints.
- Sandwich panels, insulated by expanded polyurethane (densit 40 kg/m³), sheet 23 mm thick (external 6/10 thick zinc treated).
- Fan motor units with dynamically balanced twin intake direct feed forward-curved centrifugal blades, made using galvanized steel (ISO standard 1940).
- 1-speed induction motors, all in class F except code 45227 which is in class B, with shafts turning in ball bearings and suitable for control with electronic variable voltage or auto-transformer devices.
- 1 inspection panel with triangular key.
- 1 pre-cut intake panel to accommodate square ducting.
- 1 pre-cut intake panel to accommodate round ducting.
- Operating temperature between -20 and +50 °C.
- Protection rating: IP20.
- Insulation class: Cl.I ⊕.

Fans used in VORT QBK SAL range comply with ErP N° 327/2011/UE.





KEY FEATURES

- Low noise emissions.
- Compact size.
- Designed for application in ventilation duct.
- High dependability and reduced maintenance requirement.
- Flexible installation thanks to being able to adapt the air delivery side to the system requirements by appropriately varying the arrangement of the removable panels of the enclosure depending on the needs of the system.

TECHNICAL DATA

Models	Code	V ~ Hz	W nom/max	A max	Poles	RPM	Max Airflow		Max Airflow		°C Max	IP motor	Kg
							m³/h	l/s	mmH ₂ O	Pa			
VORT QBK SAL 1000	45270	230~50/60	90 181	0.8	2	1650	547	152	35.7	350	40	54	23
VORT QBK SAL 7/7 4M 1V	45271	230~50	200 450	2.0	4	1260	1890	525	30.0	295	50	55	28
VORT QBK SAL 9/9 6M 1V	45272		250 500	2.2	6	800	2900	805	18.8	185	40		33
VORT QBK SAL 9/9 4M 1V	45273		550 1100	4.7	4	1290	3420	947	41.9	411	50		41
VORT QBK SAL 10/10 6M 1V	45274		315 640	2.9	6	600	3700	1028	26.0	255	40	46	
VORT QBK SAL 10/10 4M 1V	45225		600 2200	9.7	4	1400	5148	1426	57.5	564	40	10	42
VORT QBK SAL 12/12 6M 1V	45226		230~50/60	735 1890	8.2	6	735	5600	1551	42.0	411	50	20
VORT QBK SAL 12/12 6T 1V	45227	400~50	1100 2455	4.3	900		8000	2216	33.6	330	50	61	

VORT QBK SAL RANGE

Double inlet cabinet fans

SOUND LEVELS

Models	Code	Speed	125 Hz	250 Hz	500 Hz	1000 Hz	2000 Hz	4000 Hz	8000 Hz	Lw dB (A)	Lp dB (A) 1m*
VORT QBK SAL 1000	45270	1	28.3	34.2	40.3	43.7	39.9	19.7	8.2	46.8	38.7
VORT QBK SAL 7/7 4M 1V	45271		35.5	44.4	49.2	54.3	52.5	32.9	21.1	57.5	49.5
VORT QBK SAL 9/9 6M 1V	45272		39.3	49.9	50.7	54.1	52.7	36.8	19.2	58.3	50.2
VORT QBK SAL 9/9 4M 1V	45273		43.4	56.6	56.0	61.0	60.3	43.5	30.1	65.1	57.1
VORT QBK SAL 10/10 6M 1V	45274		39.7	53.1	51.7	54.8	53.7	36.2	19.8	59.6	51.5
VORT QBK SAL 10/10 4M 1V	45225		46.0	52.8	57.3	58.4	56.7	37.4	23.9	62.9	54.9
VORT QBK SAL 12/12 6M 1V	45226		51.9	55.4	62.5	60.6	59.3	40.0	25.1	66.3	58.3
VORT QBK SAL 12/12 6T 1V	45227		51.8		66.5	62.9	61.4	44.3	30.2	69.2	61.2

* Sound pressure level measured at 1 m in free field conditions with long-cased appliance in delivery mode, in accordance with standard EN ISO 3741.

DIMENSIONS

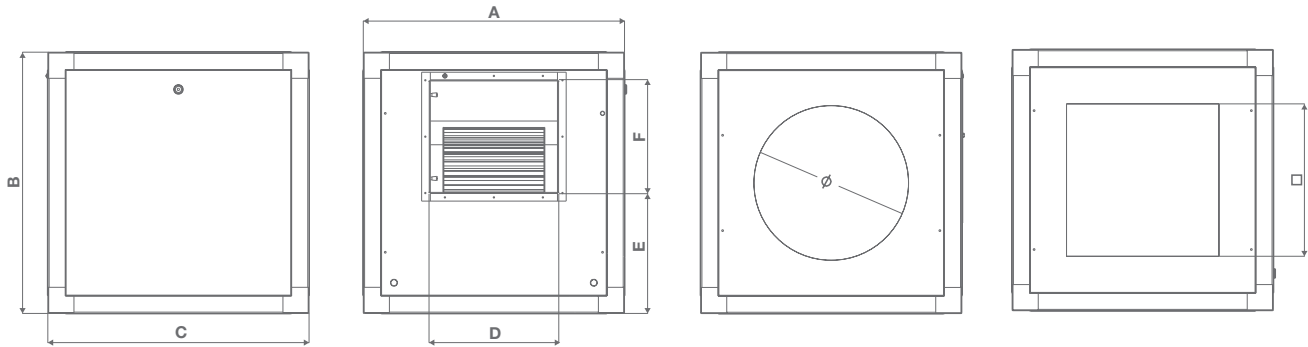

Models	A	B	C	D	E	F	Ø	□
VORT QBK SAL 1000	500	500	500	226	324	93	250	250
VORT QBK SAL 7/7 4M 1V				232	229	208		
VORT QBK SAL 9/9 6M 1V				298	175	262	355	350
VORT QBK SAL 9/9 4M 1V	298	275	262					
VORT QBK SAL 10/10 6M 1V	600	600	600	331	248	289	400	400
VORT QBK SAL 10/10 4M 1V				395	296	341	450	450
VORT QBK SAL 12/12 6M 1V	700	700	700	395	296	341	450	450
VORT QBK SAL 12/12 6T 1V				395	296	341	450	450

Dimensions (mm)



ACCESSORIES

	Description	Code	Product
	IREM 3 - Single-phase speed controller	12931	45270 - 45271 - 45274
	IREM 5 - Single-phase speed controller	12932	45273
	IREM 9 - Single-phase speed controller	12933	45225 - 45226
	IRET 6 - Three-phase speed controller	12934	45227
	QBK ABC - Air cowling	7/7 - 9/9	24200 45270 - 45271 - 45273
		10/10 - 12/12	24202 45274 - 45225 - 45226 - 45207
	QBK RRS - Round nipple joint intake	Ø 250	24205 45270 - 45271
		Ø 315	24206 45273
		Ø 400	24207 45274 - 45225
		Ø 450	24208 45226 - 45227
	QBK RRC SAL- Rain guard	7/7 - 9/9	24209 45270 - 45271 - 45273
		10/10	24210 45274 - 45225
		12/12	24211 45226 - 45227
	QBK F - Feet	24204	all models



VORT QBK SAL RANGE

Double inlet cabinet fans

PERFORMANCE CURVES

— p= delivery

VORT QBK SAL 1000

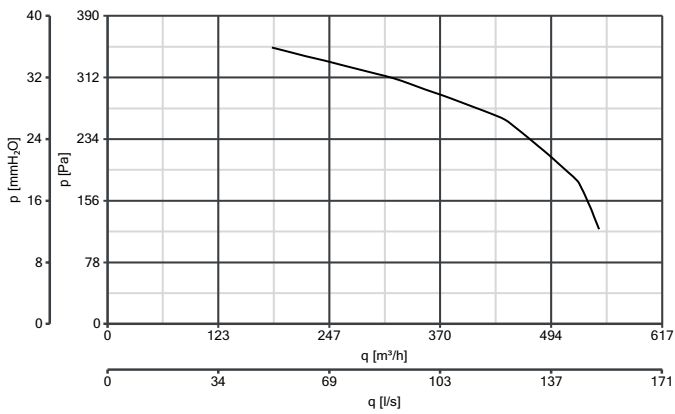

VORT QBK SAL 7/7 4M 1V

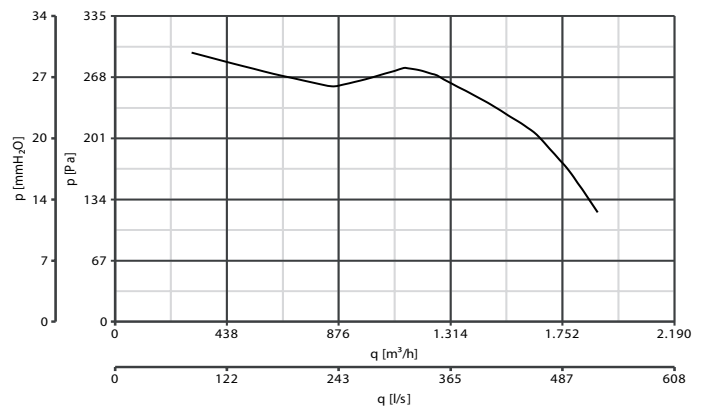

VORT QBK SAL 9/9 6M 1V

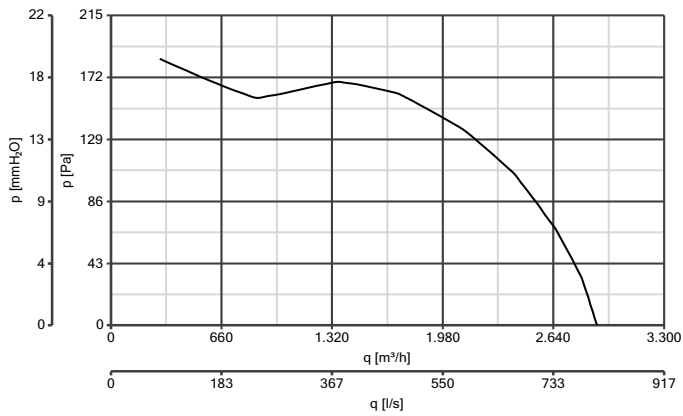

VORT QBK SAL 9/9 4M 1V

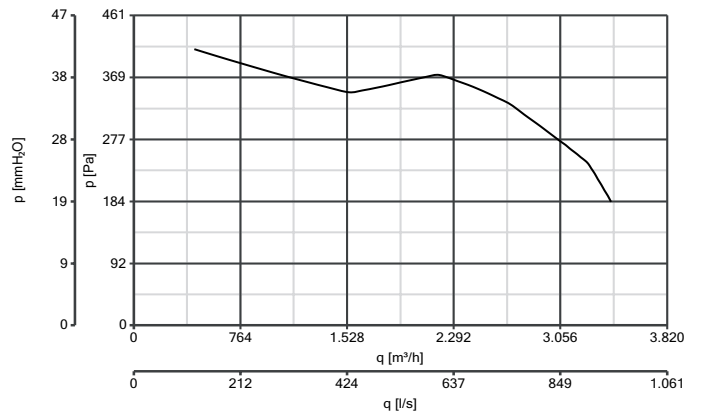

VORT QBK SAL 10/10 6M 1V

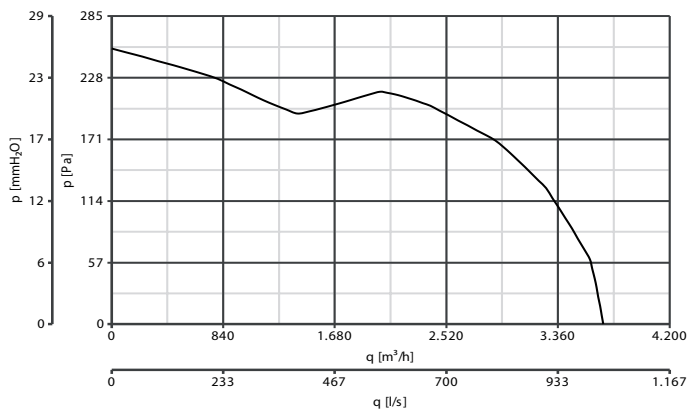

VORT QBK SAL 10/10 4M 1V

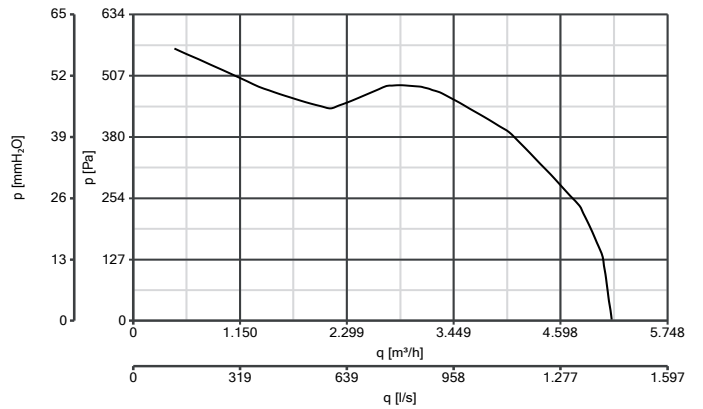



PERFORMANCE CURVES

— p= delivery

VORT QBK SAL 12/12 6M 1V

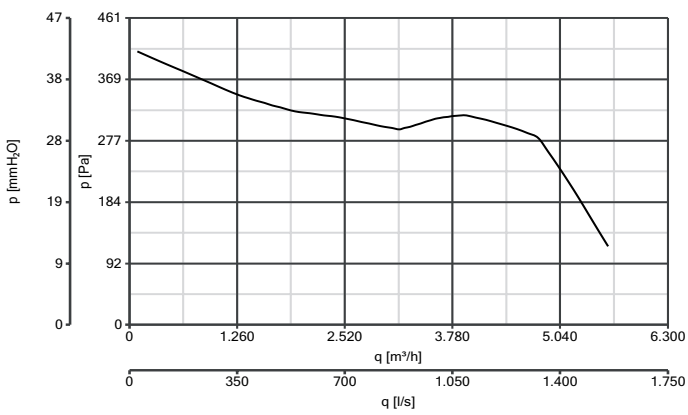

VORT QBK SAL 12/12 6T 1V

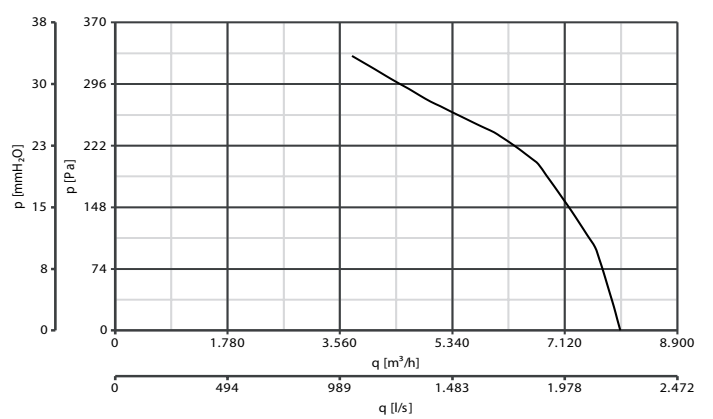

APPLICATIONS





VORT QBK SAL ES RANGE

Energy saving double inlet cabinet fans

PRODUCT SPECIFICATIONS

Designed for ducted ventilation applications: kitchens, bathrooms, offices, laboratories, factories, shops, laundry, models, restaurants, bars, theatres, ballrooms, etc.

LONG LIFE 30.000 h



- 5 models single phase.
- Flow rates up to 5400 m³/h.
- Extruded UNI 9006 aluminium frames assembled with diecast aluminium joints.
- Sandwich panels, insulated by expanded polyurethane (densit 40 kg/m³), sheet 23 mm thick (external 6/10 thick zinc treated).
- Fan motor units with dynamically balanced twin intake direct feed forward-curved centrifugal blades, made using galvanized steel (ISO standard 1940).
- Brushless motors, all in class F, with shafts turning in ball bearings and suitable for control with external potentiometer (signal 0-10 V), supplied as standard.
- 1 inspection panel with triangular key.
- 1 pre-cut intake panel to accommodate square ducting.
- 1 pre-cut intake panel to accommodate round ducting.
- Operating temperature between -20 and +40 °C.
- Protection rating: IP20.
- Insulation class: Cl.I Ⓣ.

Fans used in VORT QBK SAL ES range comply with ErP N° 327/2011/UE.

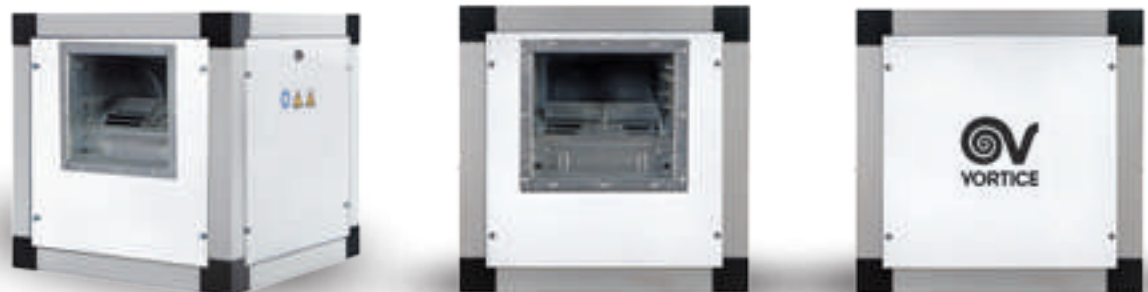



KEY FEATURES

- Low power consumption combined with high performance thanks to brushless EC motors.
- Low noise emissions.
- Wide range of speed adjustment by means of an external potentiometer (signal 0-10 V).
- High reliability and reduced maintenance requirements.
- Designed for application in ventilation duct.
- Flexible installation thanks to the possibility to adapt the air delivery side according to the system requirements by varying the setting of the removable panels of the enclosure.
- The speeds of the fan units are adjustable with an external potentiometer (0-5V or 0-10V DC signal).

TECHNICAL DATA

Models	Code	V ~ 50/60 Hz	W max	A max	RPM*	Max Airflow		Max Pressure		°C Max	IP motor	Kg
						m ³ /h	l/s	mmH ₂ O	Pa			
VORT QBK SAL ES 1000	45290	230	260	1.8	2100	1070	297	82	804	40	20	26
VORT QBK SAL ES 7/7 M	45291				2000	2940	817	60	588			
VORT QBK SAL ES 9/9 M	45292		1100	4.6	1100	3500	972	90	883			
VORT QBK SAL ES 10/10 M	45293				1000	4150	1153	120	1177		54	71
VORT QBK SAL ES 12/12 M	45295		1700	7.0	850	5400	1500	113	1108			

* RPM measured at the point of Maximum Airflow.

The performance data are relative to the F.M.W.L. (Fan Max Working Limit) maximum use curve obtained with the highest DC motor setting.



VORT QBK SAL ES RANGE

Energy saving double inlet cabinet fans

SOUND LEVELS

Models	Code	Speed	125 Hz	250 Hz	500 Hz	1000 Hz	2000 Hz	4000 Hz	8000 Hz	Lw dB (A)	Lp dB (A) 3m*
VORT QBK SAL ES 1000	45290	Max	38.9	40.7	46.4	51.4	52.3	49.4	39.6	60.9	40.9
VORT QBK SAL ES 7/7 M	45291		50.0	57.1	58.6	64.9	63.5	61.2	53.8	73.2	52.7
VORT QBK SAL ES 9/9 M	45292		49.7	50.7	64.0	60.9	59.3	57.4	47.7	71.2	50.7
VORT QBK SAL ES 10/10 M	45293		52.4	53.8	52.4	54.9	52.3	49.5	36.0	64.4	43.9
VORT QBK SAL ES 12/12 M	45295		49.9	56.9	55.0	55.8	55.7	48.4	35.8	66.4	45.9

* Sound pressure level measured at 3 m in free field conditions with long-cased appliance in delivery mode, in accordance with standard EN ISO 3741.

DIMENSIONS

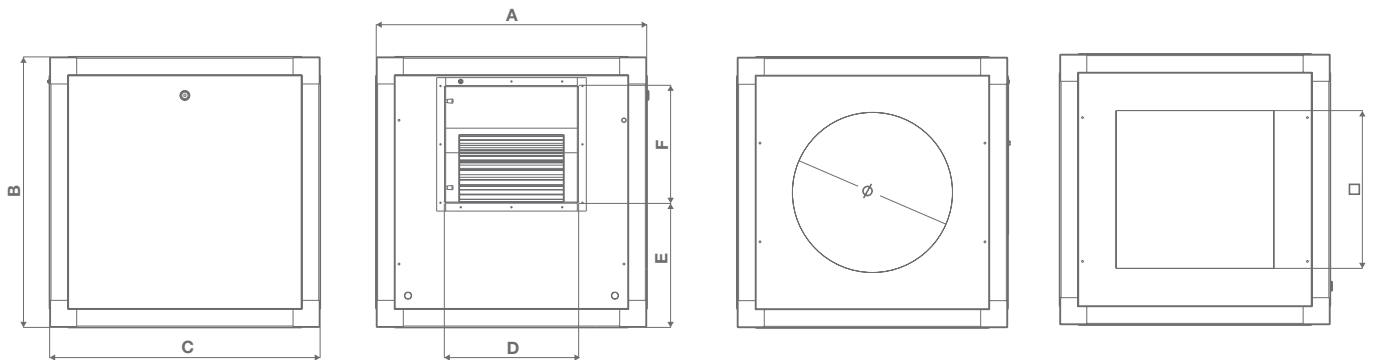

Models	A	B	C	D	E	F	Ø	□
VORT QBK SAL ES 1000	500	500	500	226	270	110	250	250
VORT QBK SAL ES 7/7 M				232	229	208		
VORT QBK SAL ES 9/9 M	600	600	600	298	170	262	355	350
VORT QBK SAL ES 10/10 M				331	248	289	400	400
VORT QBK SAL ES 12/12 M	700	700	700	395	296	341	450	450





Dimensions (mm)



VORT QBK
SAL ES
RANGE

CABINET FANS
ENERGY SAVING

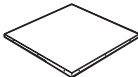
ACCESSORIES

	Description	Code	Product	
	QBK ABC - Air cowling	7/7 - 9/9	24200	45290 - 45291 - 45292
		10/10 - 12/12	24202	45293 - 45295
	QBK RRS - Round nipple joint intake	Ø 250	24205	45290 - 45291
		Ø 315	24206	45292
		Ø 400	24207	45293
		Ø 450	24208	45295
	QBK RRC SAL- Rain guard	7/7 - 9/9	24209	45290 - 45291 - 45292
		10/10	24210	45293
		12/12	24211	45295
	QBK F - Feet	24204	all models	

APPLICATIONS





VORT QBK SAL ES RANGE

Energy saving double inlet cabinet fans

PERFORMANCE CURVES

— Delivery — Power consumption

VORT QBK SAL ES 1000

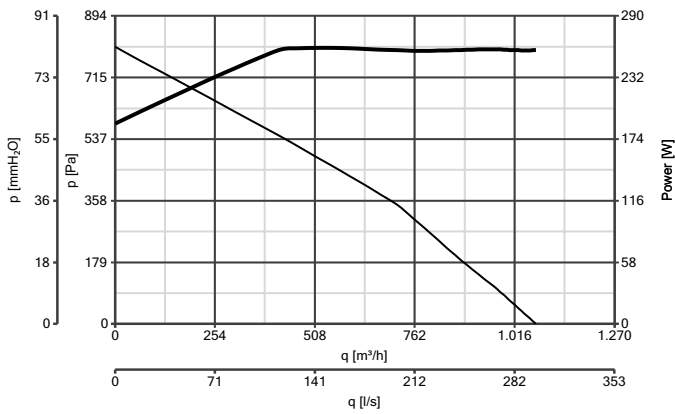

VORT QBK SAL ES 7/7 M

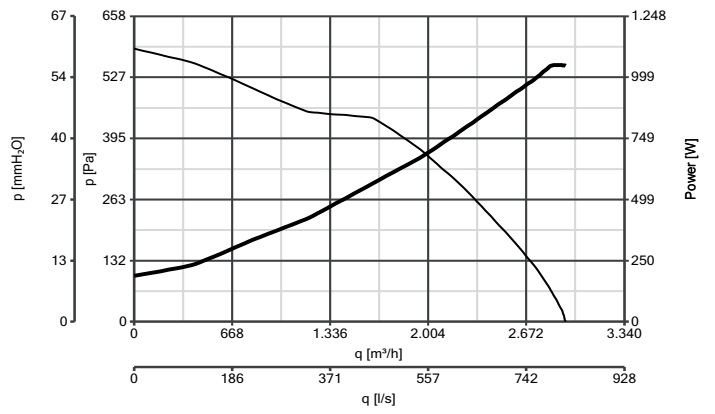

VORT QBK SAL ES 9/9 M

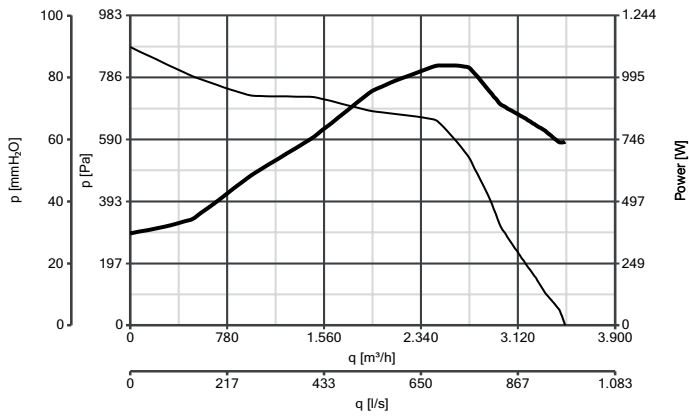

VORT QBK SAL ES 10/10 M

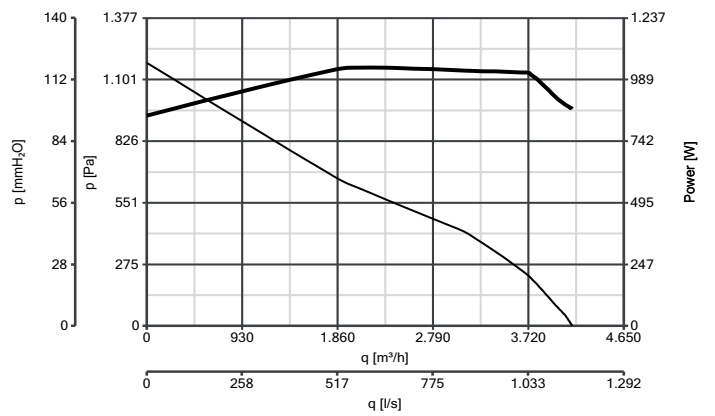

VORT QBK SAL ES 12/12 M

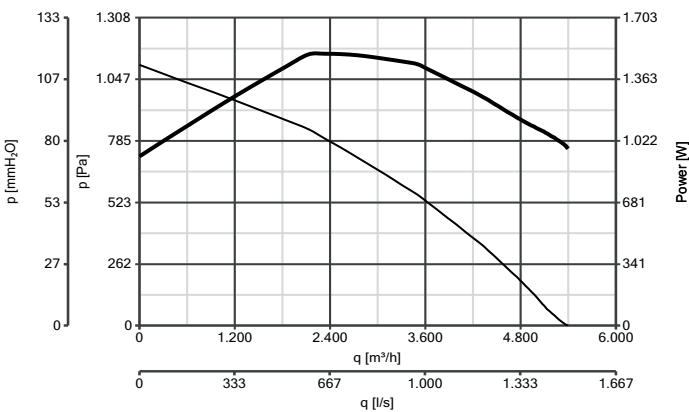

VORT QBK - SAL KC RANGE AIRSTREAM 120 °C

Cabinet fans designed to extract hot, humid, dirty air

PRODUCT SPECIFICATIONS

Ideal for ventilating industrial spaces and industrial or commercial kitchens.

LONG LIFE 30.000 h



- 8 models, 3 single phase and 5 three phase.
- Flow rates up to 16300 m³/h.
- Air flow temperatures up to maximum 120° C.
- Extruded UNI 9006 aluminium frames assembled with diecast aluminium joints.
- Zinc treated sandwich panels, sheet 23 mm thick external 6/10 thick zinc treated, sound-proof through mineral wool.
- Fan motor units with dynamically balanced twin intake direct feed forward-curved centrifugal blades, made using galvanized steel (ISO standard 1940).
- 1-speed induction motors, all in class F except codes 45278 and 45279 which are in class H, located outside the airstream and separated from the impeller by a metal panel, with shafts turning in ball bearings and suitable for control with electronic variable voltage or auto-transformer devices.
- Rectangular section delivery outlets with facility for circular outlet by fitting a specific accessory.
- Inspection panel with triangular key.
- Galvanized steel condensate drip trays with drain points and blank nut for draining.
- Galvanized steel anti-bird guards to protect the motor.
- Operating ambient temperature between -20 and +70° C.
- Protection rating: IP55.
- Insulation class: Cl.I .

Fans used in VORT QBK SAL-KC range comply with ErP N° 327/2011/UE.

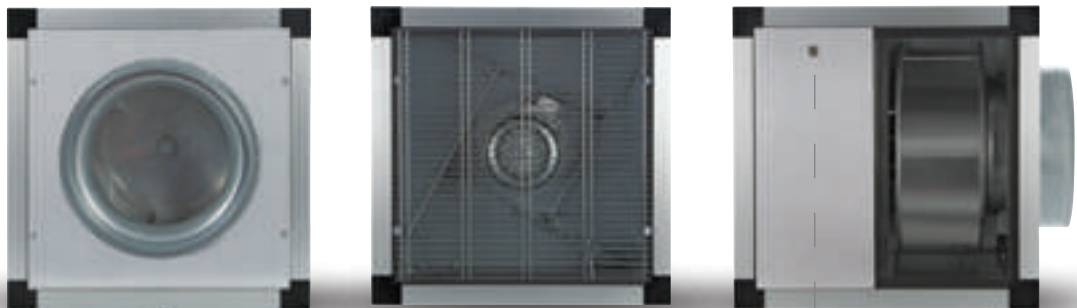

*drain for condensate /
residues*



*blank nut for
draining*



**AIRSTREAM
120 °C**

KEY FEATURES

- Can operate with airstream temperatures, up to 120 °C. Ambient temperature 70 °C for all models except QBK SAL KC T 500 (50°C) and QBK SAL KC M 400 (60°C).
- High reliability and reduced maintenance requirement.
- Low noise emissions.
- Easy access to the fan thanks to the panels with a triangular key locking device.
- High reliability and reduced maintenance requirement.
- Flexible installation: panels can be removed to fit any system requirement.
- Outdoor installation is possible by using the optional rain covers.

TECHNICAL DATA

Models	Code	V ~ 50 Hz	W nom/max	A nom/max	Poles	RPM	Max Airflow		Max Pressure		°C Max	°C Ariflow	IP motor	Kg
							m³/h	l/s	mmH ₂ O	Pa				
VORT QBK - SAL KC M 315	45266	220 - 240	275 280	1.30 1.23	4	1365	1790	497	36.1	354	70	120	55	33
VORT QBK - SAL KC M 355	45268		770 820	3.52 3.41		1355	4300	1194	46.3	454				50
VORT QBK - SAL KC M 400	45276		1130 1190	5.19 4.97		1325	6300	1750	59.2	582	60			68
VORT QBK - SAL KC T 315	45267	380 - 415	270 280	0.58 0.61	4	1420	1860	516	37.5	367	70	120	55	33
VORT QBK - SAL KC T 355	45269		790 805	1.47 1.53			4420	1227	50.0	490				50
VORT QBK - SAL KC T 400	45277		1225 1295	2.24 2.22		1390	6500	1805	63.7	625	68			
VORT QBK - SAL KC T 500	45278		2090 2180	3.65 3.55		1325	9000	2500	79.5	780	80			
VORT QBK - SAL KC T 560	45279		3520 3630	6.85 6.87	6	950	16300	4500	80.0	785	50			100



VORT QBK - SAL KC RANGE

Cabinet fans designed to extract hot, humid, dirty air

SOUND LEVELS

Models	Code	Speed	125 Hz	250 Hz	500 Hz	1000 Hz	2000 Hz	4000 Hz	8000 Hz	Lw dB (A)	Lp dB (A) 3m*
VORT QBK - SAL KC M 315	45266	Max	56.8	55.4	60.9	60.4	57.6	50.6	45.1	70.2	49.7
VORT QBK - SAL KC M 355	45268		67.1	63.7	68.5	65.8	63.6	60.6	53.4	77.8	57.3
VORT QBK - SAL KC M 400	45276		68.2	61.9	66.1	71.9	66.9	60.6	56.4	80.6	60.1
VORT QBK - SAL KC T 315	45267		55.8	55.5	61.3	60.8	58.3	51.6	45.6	70.9	50.4
VORT QBK - SAL KC T 355	45269		67.1	64.2	69.7	67.5	64.6	61.7	54.4	79.6	59.1
VORT QBK - SAL KC T 400	45277		68.8	62.1	67.3	71.9	68.1	61.1	57.0	82.9	62.4
VORT QBK - SAL KC T 500	45278		76.2	67.4	72.2	72.7	70.6	64.8	59.1	84.2	63.7
VORT QBK - SAL KC T 560	45279		60.5	68.8	73.0	76.9	78.8	67.4	61.6	86.2	65.7

* Sound pressure level measured at 3 m in free field conditions with long-cased appliance in delivery mode, in accordance with standard EN ISO 3741.

DIMENSIONS

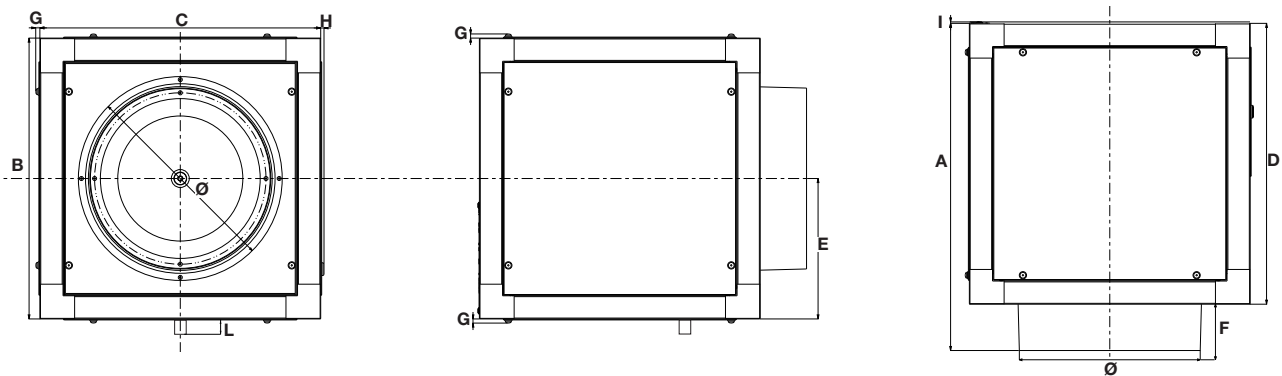

Models	A	B	C	D	E	F	G	H	I	L	Ø
VORT QBK - SAL KC 315	566	81	485	26	242.5	8	6	3	26		315
VORT QBK - SAL KC 355	671		590		295						355
VORT QBK - SAL KC 400	731		650		325						400
VORT QBK - SAL KC 500	803		722		361						500
VORT QBK - SAL KC 560	1092		1011		505.5						560



Dimensions (mm)



VORT QBK
SAL KC
RANGE

CABINET FANS
FOR EXTRACT HOT,
HUMID, DIRTY AIR

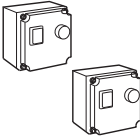
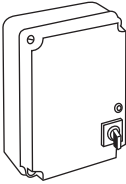
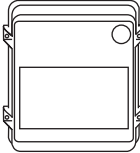
ACCESSORIES

	Description	Code	Product	
	IREM 3 - Single-phase speed controller	12931	45266	
	IREM 5 - Single-phase speed controller	12932	45268	
	IRET 6 - Three-phase speed controller	12934	45277	
	IRM 40 - Three position single phase speed controller	12922	45266	
	IRM 50 - Three position single phase speed controller	12928	45268	
	IRT 35 - Three phase variable voltage drive	12924	45267 - 45269	
	IRT 40 - Three position three phase speed controller	12927	45277 - 45278	
	IREM INVERTER 4M - Single phase speed controller	12815	45266	
	IREM INVERTER 6M - Single phase speed controller	12818	45268 - 45276	
	IRET INVERTER 2.5M - Three phase speed controller	12816	45267 - 45269	
	IRET INVERTER 5M - Three phase speed controller	12817	45277 - 45278	
	IRET INVERTER 8M - Three phase speed controller	12821	45279	
	POTENTIOMETER	12819	12815 - 12816 - 12817 - 12818	
	Circular discharger adaptor	315	24184	45266 - 45267
		355	24185	45268 - 45269
		400	24186	45276 - 45277
		500	24187	45278
		560	24135	45279
	Angled discharge section	315	24196	45266 - 45267
		355	24197	45268 - 45269
		400	24198	45276 - 45277
		500	24199	45278
		560	24138	45279



VORT QBK - SAL KC RANGE

Cabinet fans designed to extract hot, humid, dirty air

ACCESSORIES

	Description	Code	Product
	Rain guard	315 24192	45266 - 45267
		355 24193	45268 - 45269
		400 24194	45276 - 45277
		500 24195	45278
		560 24137	45279
	Anti vibration dampers	315 24188	45266 - 45267
		355 24189	45268 - 45269
		400 24190	45276 - 45277
		500/560 24191	45278- 45279
	QBK F - Feet	24144	45278 - 45279

APPLICATIONS





PERFORMANCE CURVES

— Delivery — Power consumption

VORT QBK - SAL KC M 315

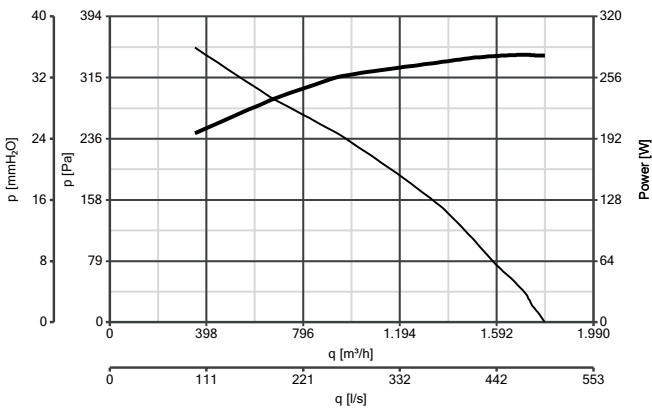

VORT QBK - SAL KC M 355

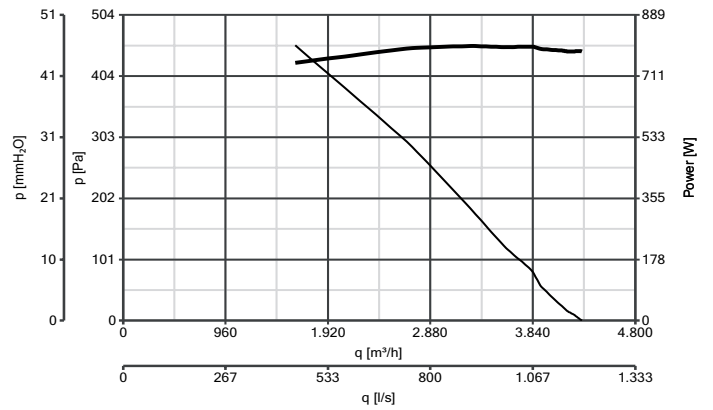

VORT QBK - SAL KC M 400

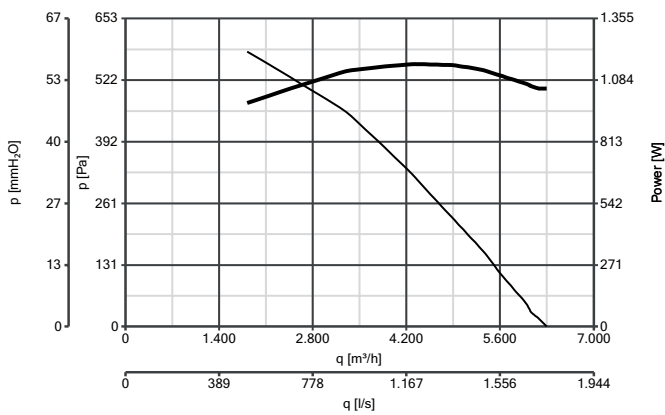

VORT QBK - SAL KC T 315

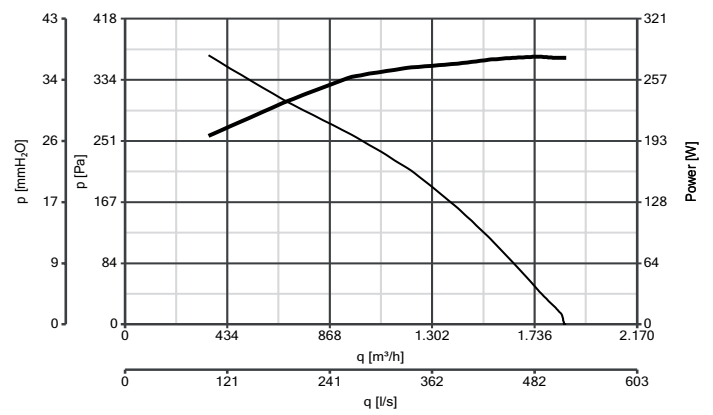

VORT QBK - SAL KC T 355

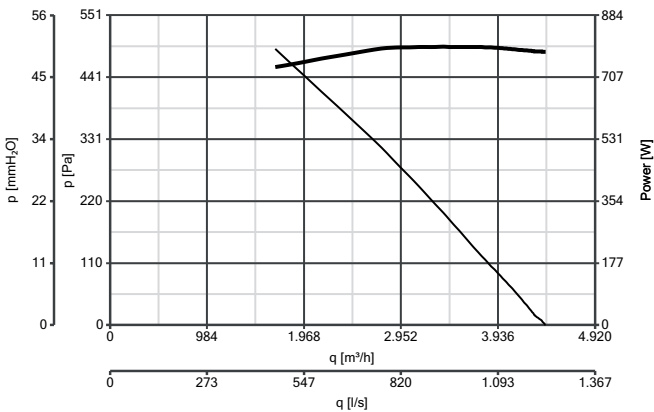

VORT QBK - SAL KC T 400

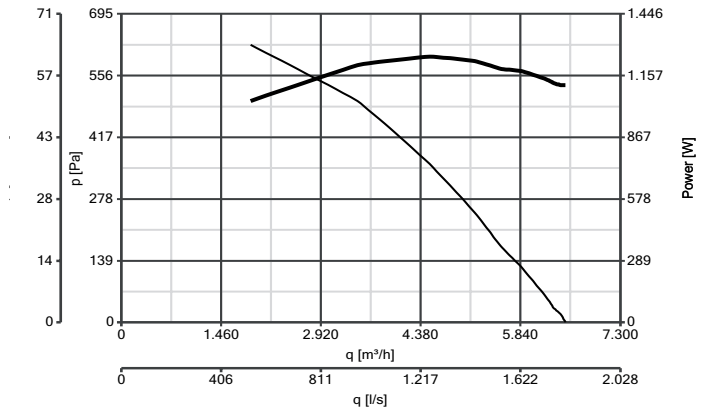



VORT QBK - SAL KC RANGE

Cabinet fans designed to extract hot, humid, dirty air

PERFORMANCE CURVES

— Delivery — Power consumption

VORT QBK - SAL KC T 500

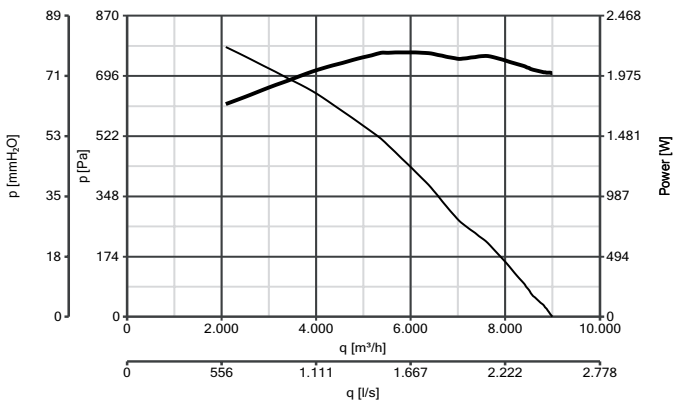

VORT QBK - SAL KC T 560

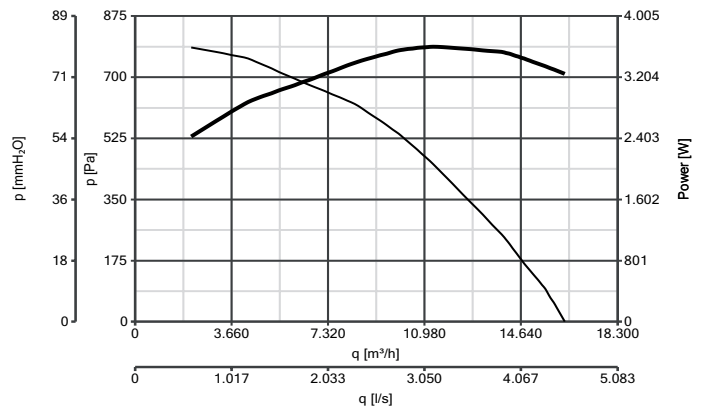

VORT QBK QUIET RANGE

Sound-proof cabinet fans for residential, commercial and industrial applications

PRODUCT SPECIFICATIONS

Appliances for ducted ventilation specifically designed to ensure low noise emissions and to facilitate installation on false ceilings thanks to their compact size.

LONG LIFE 30.000 h



- 6 models single phase nominal diameters comprehended between 100 e 315 mm.
- Flow rates up to 2420 m³/h.
- Galvanised sheet steel enclosures, fully clad with sound-absorbing, fire-resistant panels (DIN EN 13501).
- Forward curved centrifugal impellers made of galvanized steel, dynamically balanced (standard ISO 1940).
- Single-speed fans suitable for control with electronic or auto-transformer devices, and designed for continuous operation.
- Class B, external rotor motors with ball-bearings and IP44 protection rating.
- Fully removable cover for easy inspection and maintenance of internal components.
- IP55 electrical connection box complete with cable grommet diam. 20 mm.
- Covers equipped with 4 snap hinges for easy inspection and maintenance.
- Operating temperature between -15 to +50 °C.
- Protection rating: IPX4.
- Insulation class: Cl.I ⊕.

Fans used in VORT QBK QUIET Range comply with ErP N° 327/2011/UE.





KEY FEATURES

- Low noise emissions.
- Compact size.
- High reliability and reduced maintenance requirements.
- Extremely simple, flexible installation.

TECHNICAL DATA

Models	Code	V ~ 50 Hz	W max	A max	RPM	Max Airflow		Max Pressure		°C Max	Motor Class	Kg
						m ³ /h	l/s	mmH ₂ O	Pa			
VORT QBK QUIET 100	45251	230	54	0.4	2410	175	48.6	20.7	203	50	H	12
VORT QBK QUIET 125	45252		56		2268	230	63.9	20.3	199			
VORT QBK QUIET 150	45253		128	0.6	2051	520	144.4	40.6	398		B	18
VORT QBK QUIET 200	45254		133	0.6	1811	640	178.0	43.2	424			22
VORT QBK QUIET 250	45255		410	2.4	1311	1715	476.4	40.0	390		F	40
VORT QBK QUIET 315	45256		780	3.7	1390	2421	672.5	26.9	264			50



VORT QBK QUIET RANGE

Sound-proof cabinet fans for residential, commercial and industrial applications

SOUND LEVELS

Models	Code	Speed	Lp dB(A)* 3 m
VORT QBK QUIET 100	45251	outlet	24
		intake	19
		radiated	23
VORT QBK QUIET 125	45252	outlet	31
		intake	22
		radiated	22
VORT QBK QUIET 150	45253	outlet	35
		intake	30
		radiated	33
VORT QBK QUIET 200	45254	outlet	36
		intake	32
		radiated	31
VORT QBK QUIET 250	45255	outlet	41
		intake	35
		radiated	37
VORT QBK QUIET 315	45256	outlet	52
		intake	48
		radiated	39

* Sound pressure level measured at 3 m in free field conditions with long-cased appliance in delivery mode, in accordance with standard EN ISO 9614.

DIMENSIONS

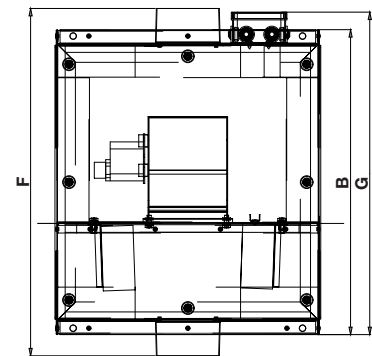
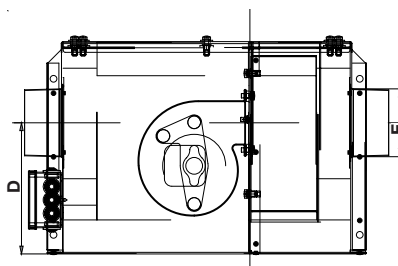
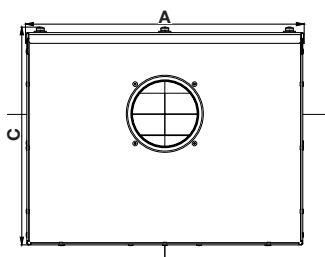

Models	A	B	C	D	Ø E	F	G
VORT QBK QUIET 100	416	477	317	195	100	544	505
VORT QBK QUIET 125					125		
VORT QBK QUIET 150	488	572	375	224	150	680	600
VORT QBK QUIET 200					200		
VORT QBK QUIET 250	609	719	551	352	250	870	746
VORT QBK QUIET 315					315		

Dimensions (mm)



VORT QBK QUIET
RANGE

CABINET FANS
ENERGY SAVING
SOUND-PROOF

ACCESSORIES

	Description	Code	Product
	C 1.5 - Regolatore elettronico di velocità monofase	11296	45251 - 45252 - 45253 - 45254
	IREM 3 - Regolatore elettronico di velocità monofase	12931	45255
	IREM 5 - Regolatore elettronico di velocità monofase	12932	45256

APPLICATIONS





VORT QBK QUIET RANGE

Sound-proof cabinet fans for residential, commercial and industrial applications

PERFORMANCE CURVES

— Delivery — Power consumption

VORT QBK QUIET 100

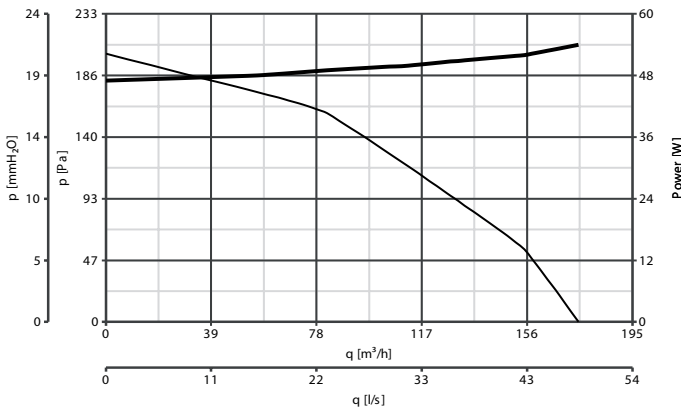

VORT QBK QUIET 125

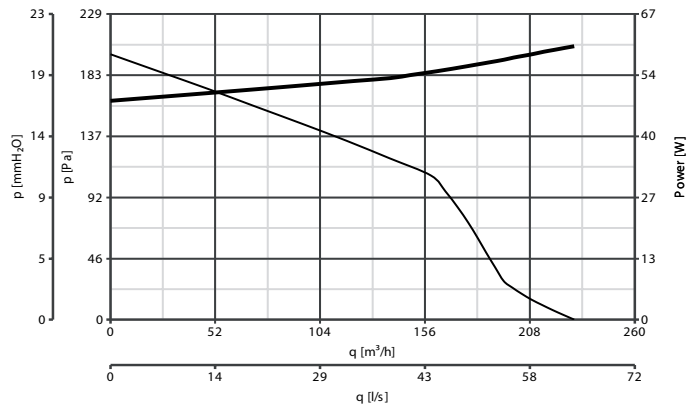

VORT QBK QUIET 150

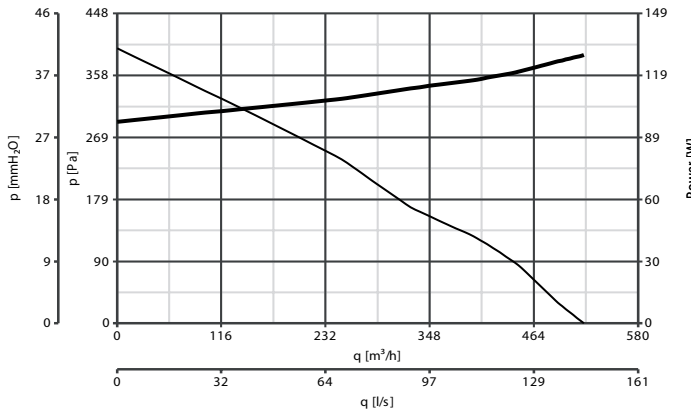

VORT QBK QUIET 200

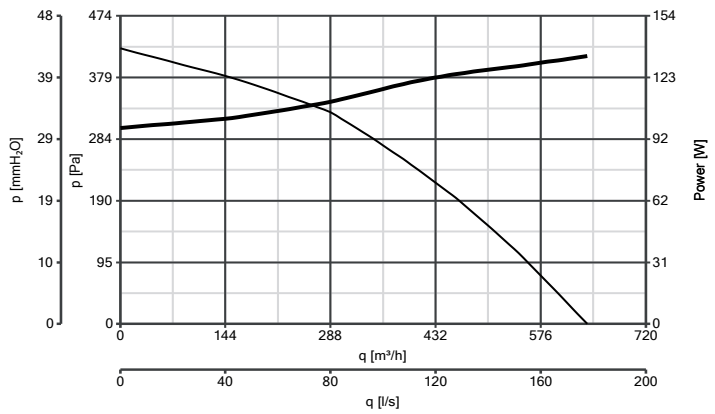

VORT QBK QUIET 250

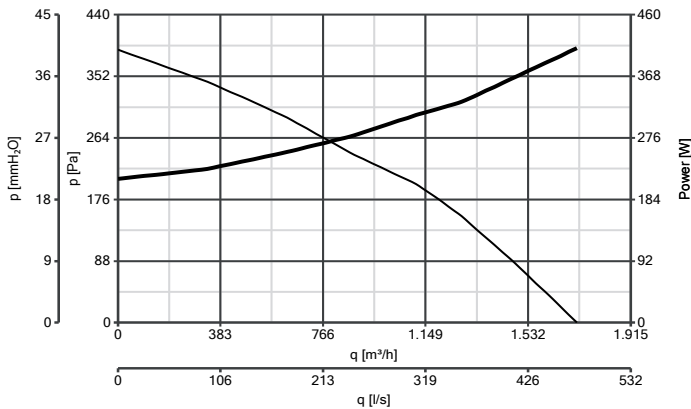

VORT QBK QUIET 315

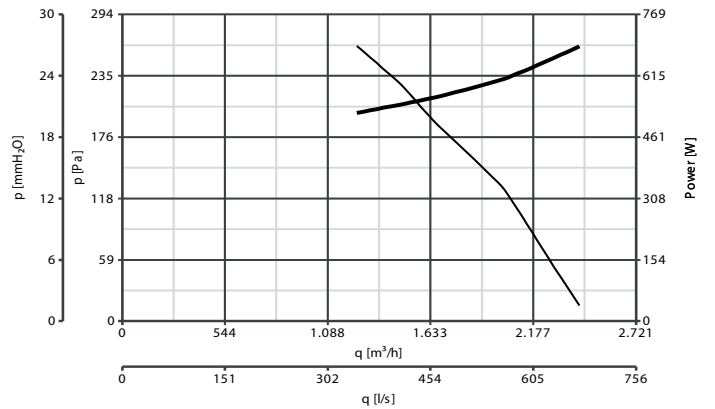



VORT TF RANGE

Twin cabinet fans for commercial and industrial applications

PRODUCT SPECIFICATIONS

Designed for situations where continuity of service is imperative, the appliances from the VORT TF series are equipped with a pair of centrifugal fans which operate in alternation. The control logic switches automatically from one fan to the other, according to cycles of 12 or 24 hours, or in the event of a fault on the fan currently in operation. It is also possible to select manually the fan you want to run, for example for maintenance purposes.

LONG LIFE 30.000 h



- 6 models: all of which can be floor- or ceiling-mounted, without any need for adaptations
In the case of the 100 and 125 models.
- Galvanised sheet steel enclosures, with 50 mm thick sound-absorbing, fire-resistant (DIN EN 13501) lining.
- Gravity-operated anti-backflow internal dampers.
- Internal conveyor flaps.
- Single-speed fans suitable for control with electronic or auto-transformer devices, and designed for continuous operation between -15 °C to + 50 °C. Class B, external rotor motors with ball-bearings and IP44 protection rating. Forward curved centrifugal impellers made of galvanized steel, dynamically balanced (standard ISO 1940).
- IP55 electrical connection box complete with cable grommet diam. 20 mm.
- External electronic device (optional) for selecting (in automatic or manual mode) the fan to run, complete with indicator lights for indicating which fan is in operation and any faults.
- Protection rating: IPX4.
- Insulation class: I Ⓣ .

Fans used in VORT TF Range comply with ErP N° 327/2011/UE.



Automatic Changeover
code 22709



KEY FEATURES

- Guaranteed continuity of operation.
- Automatic activation of the back-up fan in the event of stoppage of the fan currently in operation.
- Low noise emissions.
- Reduced height to facilitate installation on false ceilings.

Automatic Changeover controller is composed by two items:

- Electronic box for manual/automatic switching of motorfans and related fault check
- Airflow pressure switch

WARNING: The installation of both the items ensure the total control and monitoring of the VORT TF system. Installation of the Electronic box without airflow pressure switch ensures only the motorfans status and switching but airflow status is not monitored.

TECHNICAL DATA

Models	Code	V ~ 50 Hz	W	A	RPM	Max Airflow m ³ /h	Max Pressure Pa	°C Max	Motor Class	Kg
VORT TF 100	11275	230	54	0.4	2410	159	207	50	H	19
VORT TF 125	11276		56		2268	193	184			
VORT TF 150	11277		128	0.6	2051	460	406		B	28
VORT TF 200	11278		174	0.8	1811	688	475			30
VORT TF 250	11279		410	2.0	1311	1561	488		F	60
VORT TF 315	11280		780	3.7	1390	2467	264			69



VORT TF RANGE

Twin cabinet fans for commercial and industrial applications

SOUND LEVELS

VORT TF 100		Lp dB (A) 3m*
Max. Speed	Supply to internal	24
	Extract to internal	19
	Breackout	23

VORT TF 200		Lp dB (A) 3m*
Max. Speed	Supply to internal	36
	Extract to internal	32
	Breackout	31

VORT TF 125		Lp dB (A) 3m*
Max. Speed	Supply to internal	31
	Extract to internal	22
	Breackout	22

VORT TF 250		Lp dB (A) 3m*
Max. Speed	Supply to internal	41
	Extract to internal	35
	Breackout	37

VORT TF 150		Lp dB (A) 3m*
Max. Speed	Supply to internal	35
	Extract to internal	30
	Breackout	33

VORT TF 315		Lp dB (A) 3m*
Max. Speed	Supply to internal	52
	Extract to internal	48
	Breackout	39

DIMENSIONS

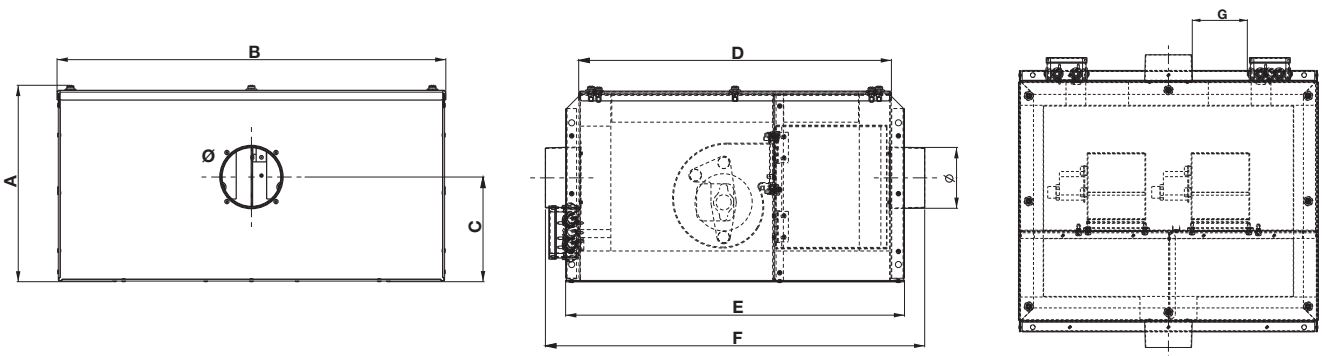

Models	A	B	C	D	E	F	G	Ø
VORT TF 100	323	639	172	517	557	623	117	100
VORT TF 125							105	125
VORT TF 150	380	784	204	614	657	763	164	150
VORT TF 200							139	200
VORT TF 250	557	1004	303	814	857	1008	204	250
VORT TF 315			296				171	315

Dimensions (mm)



PERFORMANCE CURVES

— Delivery — Power consumption

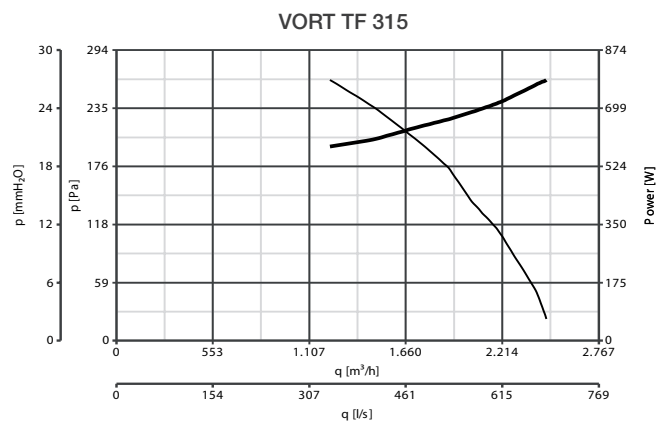
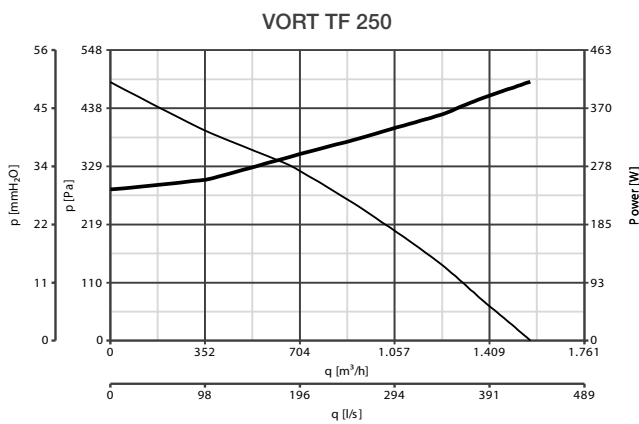
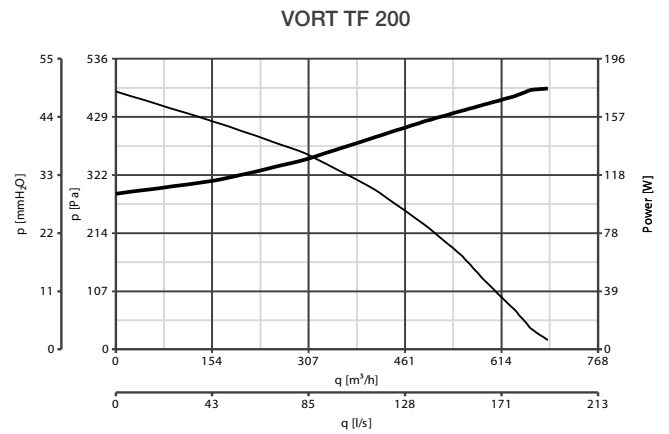
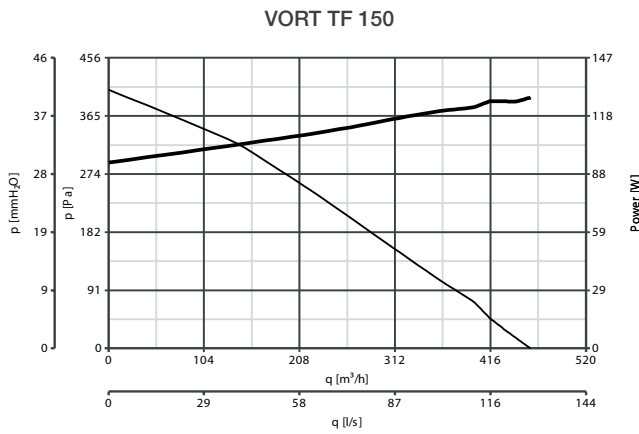
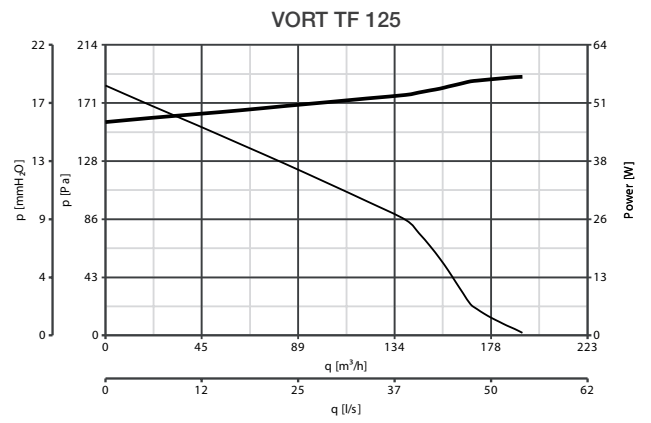
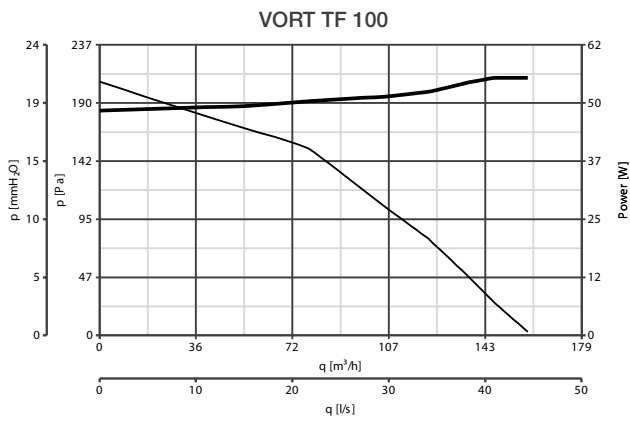



VORT QBK POWER RANGE

Sound-proof double inlet cabinet fans

PRODUCT SPECIFICATIONS

Design for ducted ventilation applications. Suitable for internal or external installations..

LONG LIFE 30.000 h



- 27 models one-speed (upon request) and 28 models two-speed (upon request).
- Flow rates up to 30000 m³/h.
- Extruded aluminium frames assembled with diecast aluminium joints.
- Zinc-coated, sound-proof frames in polyethylene padding, with metal and adhesive finishing, class I.
- One or two-speed three-phase motors, depending on model.
- Belt driven double inlet centrifugal fans equipped with forward curves centrifugal impellers.
- Access through removeable panels or hinged door depending on model.
- Operating temperature between -20°C and +40°C. Operation at higher temperatures allowed, accepting a power drop.
- Designed for ducted ventilation applications.
- Suitable for internal or external installations.
- Insulation class: I ⊕ .

Fans used in VORT QBK POWER Range comply with ErP N° 327/2011/UE.



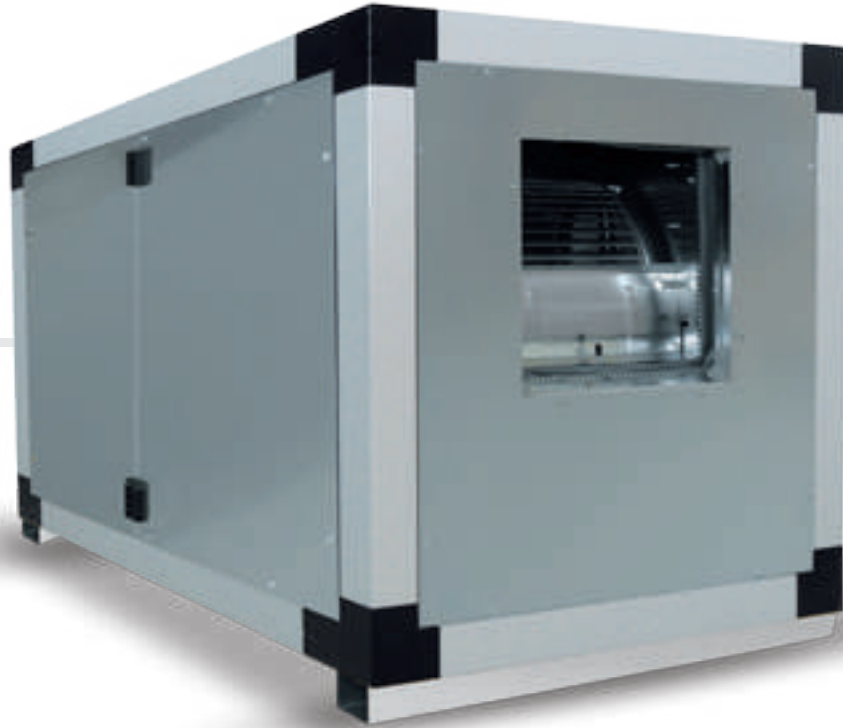

TECHNICAL DATA

Models	Code	Speed	V ~ 50 Hz	kW nom.	A nom.	RPM	Max Airflow m ³ /h	Lp (dBA)* 1m max	Kg	Amb temp. max (°C)	Motor Class	IP Motor
VORT QBK POWER 9/7 1V 0.75	45303	1	230	0.75	1.93	1030	2500	69	58	40	F	55
VORT QBK POWER 9/9 1V 0.75	45306		230	0.75	1.93	1590	3500	72	62	40	F	
VORT QBK POWER 9/9 1V 1.1	45307		230	1.1	2.64	1600	3500	73	62	40	F	
VORT QBK POWER 10/10 1V 0.75	45309		230	0.75	1.93	1050	4500	71	83	40	F	
VORT QBK POWER 10/10 1V 1.1	45310		230	1.1	2.64	1345	4500	73	83	40	F	
VORT QBK POWER 10/10 1V 1.5	45311		230	1.5	3.45	1360	4500	74	83	40	F	
VORT QBK POWER 12/12 1V 0.75	45312		230	0.75	1.93	735	5000	68	104	40	F	
VORT QBK POWER 12/12 1V 1.1	45313		230	1.1	2.64	1020	6000	71	104	40	F	
VORT QBK POWER 12/12 1V 1.5	45314		230	1.5	3.45	1150	7000	75	104	40	F	
VORT QBK POWER 12/12 1V 2.2	45315		230	2.2	4.84	1150	7000	76	104	40	F	
VORT QBK POWER 15/15 1V 1.1	45316		230	1.1	2.64	640	7000	70	139	40	F	
VORT QBK POWER 15/15 1V 1.5	45317		230	1.5	3.45	740	9000	73	139	40	F	



VORT QBK POWER RANGE

Sound-proof double inlet cabinet fans

TECHNICAL DATA

Models	Code	Speed	V ~ 50 Hz	kW nom.	A nom.	RPM	Max Airflow m³/h	Lp (dBA)* 1m max	Kg	Amb temp. max (°C)	Motor Class	IP Motor
VORT QBK POWER 15/15 1V 2.2	45318	1	230	2.2	4.84	950	10000	77	139	40	F	55
VORT QBK POWER 15/15 1V 3	45319		230	3	6.47	960	10000	78	139	40	F	
VORT QBK POWER 18/18 1V 1.5	45320		230	1.5	3.45	520	10000	72	208	40	F	
VORT QBK POWER 18/18 1V 2.2	45321		230	2.2	4.84	730	14000	79	208	40	F	
VORT QBK POWER 18/18 1V 3	45322		230	3	6.47	820	14000	79	208	40	F	
VORT QBK POWER 18/18 1V 4	45323		230	4	8.26	820	14000	82	208	40	F	
VORT QBK POWER 18/18 1V 5.5	45324		230	5.5	11.03	820	14000	82	208	40	F	
VORT QBK POWER 560 1V 3	45325		230	3	6.47	600	18000	73	276	40	F	
VORT QBK POWER 560 1V 4	45326		230	4	8.26	670	20000	76	276	40	F	
VORT QBK POWER 560 1V 5.5	45327		230	5.5	11.03	770	22000	78	276	40	F	
VORT QBK POWER 560 1V 7.5	45328		230	7.5	14.64	790	22000	79	276	40	F	
VORT QBK POWER 630 1V 4	45329		230	4	8.26	460	22000	73	276	40	F	
VORT QBK POWER 630 1V 5.5	45330		230	5.5	11.03	600	27000	78	348	40	F	
VORT QBK POWER 630 1V 7.5	45331		230	7.5	14.64	670	27000	80	348	40	F	
VORT QBK POWER 630 1V 11	45333	230	11	20.64	700	27000	81	348	40	F		



TECHNICAL DATA

Models	Code	Speed	V ~ 50 Hz	kW nom.	A nom.	RPM	Max Airflow m³/h	Lp (dBA)* 1m max	Kg	Amb temp. max (°C)	Motor Class	IP Motor
VORT QBK POWER 9/7 2V 0.55	45342	2	400	0.5-0.19	1.4-0.7	1520	2500	72	58	40	F	55
VORT QBK POWER 9/7 2V 0.75	45343		400	0.66-0.25	1.75-0.8	1490	2500	73	58	40	F	
VORT QBK POWER 9/9 2V 0.55	45345		400	0.5-0.19	1.4-0.7	1420	3500	72	62	40	F	
VORT QBK POWER 9/9 2V 0.75	45346		400	0.66-0.25	1.75-0.8	1590	3500	72	62	40	F	
VORT QBK POWER 9/9 2V 1.1	45347		400	1-0.3	2.5-1.2	1600	3500	73	62	40	F	
VORT QBK POWER 10/10 2V 0.55	45348		400	0.5-0.19	1.4-0.7	895	3500	72	83	40	F	
VORT QBK POWER 10/10 2V 0.75	45349		400	0.66-0.25	1.75-0.8	1050	4500	71	83	40	F	
VORT QBK POWER 10/10 2V 1.1	45350		400	1-0.3	2.5-1.2	1345	4500	73	83	40	F	
VORT QBK POWER 10/10 2V 1.5	45351		400	1.5-0.45	3.5-1.6	1360	4500	74	83	40	F	
VORT QBK POWER 12/12 2V 0.75	45352		400	0.66-0.25	1.75-0.8	735	5000	68	104	40	F	
VORT QBK POWER 12/12 2V 1.1	45353		400	1-0.3	2.5-1.2	1020	6000	71	104	40	F	
VORT QBK POWER 12/12 2V 1.5	45354		400	1.5-0.45	3.5-1.6	1150	7000	75	104	40	F	
VORT QBK POWER 12/12 2V 2.2	45355		400	2-0.6	4.5-2	1150	7000	76	104	40	F	
VORT QBK POWER 15/15 2V 1.1	45356		400	1-0.3	2.5-1.2	640	7000	70	139	40	F	
VORT QBK POWER 15/15 2V 1.5	45357		400	1.5-0.45	3.5-1.6	740	9000	73	139	40	F	
VORT QBK POWER 15/15 2V 2.2	45358		400	2-0.6	4.5-2	950	10000	77	139	40	F	
VORT QBK POWER 15/15 2V 3	45359		400	3-1	6.3-3.1	960	10000	78	139	40	F	
VORT QBK POWER 18/18 2V 1.5	45360		400	1.5-0.45	3.5-1.6	520	10000	72	208	40	F	
VORT QBK POWER 18/18 2V 2.2	45361		400	2-0.6	4.5-2	730	14000	79	208	40	F	
VORT QBK POWER 18/18 2V 3	45362		400	3-1	6.3-3.1	820	14000	79	208	40	F	
VORT QBK POWER 18/18 2V 4	45363		400	4.5-1.5	9.2-5.1	820	14000	82	208	40	F	
VORT QBK POWER 18/18 2V 5.5	45364		400	6-2	12-5.6	820	14000	82	208	40	F	
VORT QBK POWER 560 2V 3	45365		400	3-1	6.3-3.1	600	18000	73	276	40	F	
VORT QBK POWER 560 2V 4	45366		400	4.5-1.5	9.2-5.1	670	20000	76	276	40	F	
VORT QBK POWER 560 2V 5.5	45367		400	6-2	12-5.6	770	22000	78	276	40	F	
VORT QBK POWER 630 2V 4	45369		400	4.5-1.5	9.2-5.1	460	22000	73	348	40	F	
VORT QBK POWER 630 2V 5.5	45370		400	6-2	12-5.6	600	27000	78	348	40	F	
VORT QBK POWER 630 2V 11	45373		400	10.5-3.5	21-8.6	700	27000	81	348	40	F	

NOTE: Operation at higher temperatures is also possible. At higher temperatures however, there is a drop in power (contact our technical-sales office).

* Sound pressure level measured at 1 m in free field conditions.



VORT QBK POWER RANGE

Sound-proof double inlet cabinet fans

DIMENSIONS

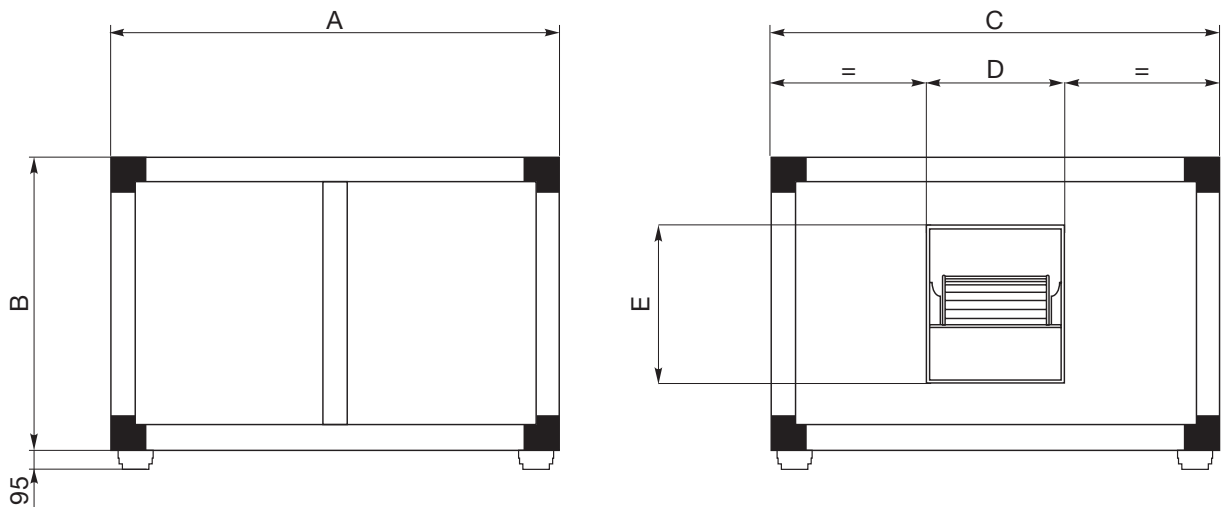

Models	A	B	C	D	E
VORT QBK POWER 9/7	790	600	600	235	265
VORT QBK POWER 9/9				300	
VORT QBK POWER 10/10	1040	700	700	335	295
VORT QBK POWER 12/12		790	790	395	340
VORT QBK POWER 15/15		1040	1040	470	405
VORT QBK POWER 18/18	1290	1290	1290	560	480
VORT QBK POWER 560	1540			640	640
VORT QBK POWER 630		1540	1540	1540	720

Dimensions (mm)

NOTE: The overall dimensions of QBK POWER are indicative since they are subject to change upon final order confirmation. In case the unit is fitted with the filtering section accessory, dimension A will increase by 250 mm.



ACCESSORIES

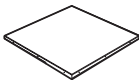
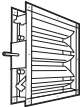



	Description	Code	Product
	QBK RRC POWER 9/7 - 9/9 Rain guard	24215	45300 - 45301 - 45302 - 45303 - 45304 - 45305 - 45306 - 45307 45340 - 45341 - 45342 - 45343 - 45344 - 45345 - 45346 - 45347
	QBK RRC POWER 10/10 Rain guard	24216	45308 - 45309 - 45310 - 45311 45348 - 45349 - 45350 - 45351
	QBK RRC POWER 12/12 Rain guard	24217	45312 - 45313 - 45314 - 45315 - 45352 - 45353 - 45354 - 45355
	QBK RRC POWER 15/15 Rain guard	24218	45316 - 45317 - 45318 - 45319 - 45356 - 45357 - 45358 - 45359
	QBK RRC POWER 18/18 Rain guard	24219	45320 - 45321 - 45322 - 45323 - 45324 - 45360 - 45361 - 45362 45363 - 45364
	QBK RRC POWER 560 Rain guard	24220	45325 - 45326 - 45327 - 45328 - 45365 - 45366 - 45367 - 45368
	QBK RRC POWER 630 Rain guard	24221	45329 - 45330 - 45331 - 45332 - 45333 - 45369 - 45370 - 45371 45372 - 45373
	QBK VCD POWER 9/7 - 9/9 Adjustment shutter	24222	45300 - 45301 - 45302 - 45303 - 45304 - 45305 - 45306 - 45307 45340 - 45341 - 45342 - 45343 - 45344 - 45345 - 45346 - 45347
	QBK VCD POWER 10/10 Adjustment shutter	24223	45308 - 45309 - 45310 - 45311 45348 - 45349 - 45350 - 45351
	QBK VCD POWER 12/12 Adjustment shutter	24224	45312 - 45313 - 45314 - 45315 - 45352 - 45353 - 45354 - 45355
	QBK VCD POWER 15/15 Adjustment shutter	24225	45316 - 45317 - 45318 - 45319 - 45356 - 45357 - 45358 - 45359
	QBK VCD POWER 18/18 Adjustment shutter	24226	45320 - 45321 - 45322 - 45323 - 45324 - 45360 - 45361 - 45362 45363 - 45364
	QBK VCD POWER 560 Adjustment shutter	24227	45325 - 45326 - 45327 - 45328 - 45365 - 45366 - 45367 - 45368
	QBK VCD POWER 630 Adjustment shutter	24228	45329 - 45330 - 45331 - 45332 - 45333 - 45369 - 45370 - 45371 45372 - 45373

Accessories of cabinet VORT QBK POWER cannot be ordered separately but only in association with them. The required accessories will be mounted directly on the cabinets prior to delivery.

VORT QBK POWER RANGE

Sound-proof double inlet cabinet fans

ACCESSORIES

	Description	Code	Product
	QBK IG 9/7 - 9/9 Intake grille	24230	45300 - 45301 - 45302 - 45303 - 45304 - 45305 - 45306 - 45307 45340 - 45341 - 45342 - 45343 - 45344 - 45345 - 45346 - 45347
	QBK IG 10/10 Intake grille	24231	45308 - 45309 - 45310 - 45311 45348 - 45349 - 45350 - 45351
	QBK IG 12/12 Intake grille	24232	45312 - 45313 - 45314 - 45315 - 45352 - 45353 - 45354 - 45355
	QBK IG 15/15 Intake grille	24233	45316 - 45317 - 45318 - 45319 - 45356 - 45357 - 45358 - 45359
	QBK IG 18/18 Intake grille	24234	45320 - 45321 - 45322 - 45323 - 45324 - 45360 - 45361 - 45362 45363 - 45364
	QBK IG 560 Intake grille	24235	45325 - 45326 - 45327 - 45328 - 45365 - 45366 - 45367 - 45368
	QBK IG 630 Intake grille	24236	45329 - 45330 - 45331 - 45332 - 45333 - 45369 - 45370 - 45373
	QBK SS Safety micro-switch	24237	for all models
	QBK VDP 9 - 10 - 12 - 15 - 18 Variable pulley	24238	45300 - 45301 - 45302 - 45303 - 45304 - 45305 - 45306 - 45307 - 45340 - 45341 - 45342 - 45343 - 45344 - 45345 - 45346 - 45347
	QBK VDP 560 - 630 Variable pulley	24239	45325 - 45326 - 45327 - 45328 - 45329 - 45330 - 45331 - 45332 45333 - 45365 - 45366 - 45367 - 45368 - 45369 - 45370 - 45373
	QBK FS 9/7 - 9/9 Filtering section	24240	45300 - 45301 - 45302 - 45303 - 45304 - 45305 - 45306 45307 - 45342 - 45343 - 45345 - 45346 - 45347
	QBK FS 10/10 Filtering section	24241	45308 - 45309 - 45310 - 45311 45348 - 45349 - 45350 - 45351
	QBK FS 12/12 Filtering section	24242	45312 - 45313 - 45314 - 45315 - 45352 - 45353 - 45354 - 45355
	QBK FS 15/15 Filtering section	24243	45316 - 45317 - 45318 - 45319 - 45356 - 45357 - 45358 - 45359
	QBK FS 18/18 Filtering section	24244	45320 - 45321 - 45322 - 45323 - 45324 - 45360 - 45361 - 45362 - 45363 - 45364
	QBK FS 560 Filtering section	24245	45325 - 45326 - 45327 - 45328 - 45365 - 45366 - 45367 - 45368
	QBK FS 630 Filtering section	24246	45329 - 45330 - 45331 - 45332 - 45333 - 45369 - 45370 - 45372 - 45373
	QBK ABC 7/7 - 9/9 Filtering section	24200	45301 - 45302 - 45303 - 45304 - 45305 - 45306 - 45307 - 45342 45343 - 45345 - 45346 - 45347
	QBK ABC 10/10 - 12/12 Air cowling	24202	45308 - 45309 - 45310 - 45311 - 45348 - 45349 - 45350 - 45351 45312 - 45313 - 45314 - 45315 - 45352 - 45353 - 45354 - 45355

Accessories of cabinet VORT QBK POWER cannot be ordered separately but only in association with them. The required accessories will be mounted directly on the cabinets prior to delivery.

Cod. 5.170.084.994

09/15

Vortice Elettrosociali S.p.A
Strada Cerca, 2
Frazione di Zoate
20067 Tribiano (Milano)
Tel. (+39) 02 906991
Fax (+39) 02 90699314
Italia
www.vortice.com
export@vortice-italy.com

Vortice France
15-33, Rue Le Corbusier
CS 30007
94046 Créteil Cedex
Tél. (+33) 1.55.12.50.00
Fax (+33) 1.55.12.50.01
France
www.vortice-france.com
contact@vortice-france.com

Vortice Limited
Beeches House-Eastern Avenue
Burton on Trent
DE13 0BB
Tel. (+44) 1283-49.29.49
Fax (+44) 1283-54.41.21
United Kingdom
www.vortice.ltd.uk
sales@vortice.ltd.uk

